

DOI: <https://doi.org/10.15276/aait.02.2021.2>

UDC 685.511 + 62-83

PASSIVITY-BASED CONTROL SYSTEM FOR STAND-ALONE HYBRID ELECTROGENERATING COMPLEX

Yurii O. Biletskyi¹⁾ORCID: <https://orcid.org/0000-0001-6988-0825>; yurii.o.biletskyi@lpnu.ua. Scopus ID: 56470782400Ihor Z. Shchur¹⁾ORCID: <https://orcid.org/0000-0001-7346-1463>; ihor.z.shchur@lpnu.ua. Scopus ID: 36348908300Rostyslav-Ivan V. Kuzyk¹⁾ORCID: <https://orcid.org/0000-0002-6483-2223>; rostyslav-ivan.kuzyk.mnee.2019@lpnu.ua¹⁾Lviv Polytechnic National University. 12, S. Bandery Str. Lviv, 79013, Ukraine

ABSTRACT

The desire for energy independence presupposes the use of various types of elements for energy generation from renewable sources, for the stand-alone operation of which energy storage devices are required. A power generation complex created in this way must perform a number of tasks that are formed by the energy management system. The control system performs these tasks and ensures proper static and dynamic characteristics of this complex with many inputs and outputs. The results of recent world researches, as well as the authors experience of this work, show that, for creating such control systems, it is advisable to use Passive-Based Control (PBC), presenting the control object as a Port-Controlled Hamiltonian (PCH) system. Thanks to the developed method of additional interconnections and damping injection (Interconnection & Damping Assignment - IDA) passive control provides ample opportunities to adjust the control effects, while ensuring the asymptotic stability of the system as a whole. This is particularly useful in the complex system considered in this paper that includes both a hybrid power plant for electricity generation from the sun and wind and a hybrid energy storage unit consisting of the battery and supercapacitor module. This article shows the procedure of PBC system synthesis, according to which three structures of control influence formers (CIF) were designed and investigated. These structures have different combinations of additional interconnections and damping, which allows forming the desired energy flows inside the closed-loop system and therefore provide desired control results. Among them, there are tasks of maintaining voltages on the DC bus and the supercapacitor module at reference levels, and the smoothness of the battery current transients. A comparative simulation studies were performed on a computer model of the power generation complex with synthesized control systems, which was created in the MATLAB/Simulink environment. It showed the efficiency of their work and the advantages of different CIF structures.

Keywords: Energy Generating Complex; Photovoltaics; Wind Power Plant; Hybrid Battery-Supercapacitor Energy Storage System; Passivity-Based Control (PBC); Port-Controlled Hamiltonian System (PCH); Synthesis by Interconnections and Damping Assignment (IDA)

For citation: Biletskyi Yu. O., Shchur I. Z., Kuzyk R.-I. V. Passivity-Based Control System for Stand-Alone Hybrid Electrogenerating Complex. *Applied Aspects of Information Technology*. 2021; Vol. 4 No. 2: 140–152. DOI: <https://doi.org/10.15276/aait.02.2021.2>

INTRODUCTION

Modern scientific and technical base opens up many opportunities of using devices for electricity generation from renewable sources, as well as energy storage units under the conditions of autonomous power plants. This is especially true for remote consumers, whose connection to the central grid requires significant investment, which is unprofitable. Another category of consumers of autonomous power generation complexes are those who seek for energy independence. Therefore, the use of new means of electricity generation together with its accumulation is an urgent modern task [1, 2].

From technical and economical points of view,

hybrid systems for both energy generation and energy storage are the most efficient. At the same time, some tools complement others. Among combinations of several generation sources, a combination of wind turbines and solar photovoltaic installations is often used, because they mainly work at different times and in different weather conditions [3, 4], [5]. Among hybrid energy storage systems, a combination of batteries with supercapacitors is often used [6, 7].

Rechargeable batteries as accumulators of electricity have a long service life at constant and low load currents; however, abruptly changing and heavy loads significantly reduce their service life [8]. Supercapacitor modules (SCM) composed of individual supercapacitors with high capacitances, in a hybrid energy storage system, take large and fast loads on themselves, protecting the battery and

increasing its lifetime [9, 10]. The efficient operation of hybrid integrated energy generation and energy storage systems requires the development of multifunctional, stable and fast control systems for such multi-input complex objects, which need to provide qualitative control characteristics.

The proposed solution of this challenge is to use a passivity-based control system, which thanks to the interconnections and damping assignment allows forming characteristics while ensuring the asymptotic stability of a complex nonlinear system [11].

LITERATURE REVIEW

Integrated hybrid energy generation and storage systems as control objects are complex and usually nonlinear dynamic systems with many inputs and many outputs (Multiple Input Multiple Output – MIMO). In addition, the management of such complexes is characterized by multi functionality. All this significantly complicates the task of creating qualitative control systems for such complexes. Therefore, the latest rather complex methods of modern control theory of nonlinear systems are used to create control systems, in particular: Adaptive Sliding-Mode Control (ASMC) [12], Model Predictive Control (MPC) [13], Fraction Order Control (FOC) [14], intelligent control methods (FLC – Fuzzy Logic Control) [15], energy approaches (FC – Flatness Control [16] and PBC – Passivity-Based Control [17]). Among them, PBC and its structural synthesis by the procedure of Interconnection and Damping Assignment (IDA) have a clear understanding of energy patterns during the formation of control effects, as well as ease of asymptotic stabilization of synthesized systems [18, 19]. Many complex nonlinear object control systems have been successfully synthesized using the IDA-PBC method, such as [20, 21], [22].

In our work, we have successfully applied PBC to wind and photovoltaic systems, as well as hybrid battery-supercapacitor systems of electricity storage [23, 24], [25, 26], [27]. The experience gained in the use of PBC has allowed us to develop a method of structural synthesis of possible control influences that ensure the stability of the system. It consists in developing for a specific dynamic object its mathematical model in the form of a port-controlled Hamiltonian (PCH) system and creating in the MathCad computing environment a corresponding program. This program symbolically solves a system

of nonlinear equations with predetermined interconnection between system elements and damping effects and gives expressions for control influences that ensure the stability of the system [28].

The energy-shaping control is based on the function of the total energy of the system (Hamiltonian), which has the form:

$$H(\mathbf{x}) = \frac{1}{2} \mathbf{x}^T \mathbf{D}^{-1} \mathbf{x}, \quad (1)$$

where: \mathbf{x} is the state vector of the system; \mathbf{D} is the diagonal matrix of inertia coefficients of the system.

Any system is considered and described as PCH in the form of the following vector-matrix equation:

$$\dot{\mathbf{x}}(t) = [\mathbf{J}_d(\mathbf{x}) - \mathbf{R}_d(\mathbf{x})] \nabla H(\mathbf{x}) + \mathbf{G}(\mathbf{x}) \mathbf{u}(t), \quad (2)$$

where: $\mathbf{J}(\mathbf{x})$ is the skew-symmetric matrix that describes interconnections in the system; $\mathbf{R}(\mathbf{x})$ is the symmetric matrix that describes damping in the system; $\mathbf{G}(\mathbf{x})$ is the port matrix; $\mathbf{u}(t)$ is the vector of control influences; $\mathbf{y}(t)$ is the vector of output energy variables.

The main idea of PBC (energy-shaping control), in particular by the IDA-PBC method, is the purposeful formation of the energy function (1) of the system (2) and, thus, the impact on transients and steady processes in it [29], [11]. In a closed-loop system, the desired energy function H_d is formed to be such that at its minimum the system will be at a given equilibrium point $\bar{\mathbf{x}}$.

The synthesis of the PBC system consists in finding the following additional interconnections \mathbf{J}_a and damping \mathbf{R}_a , which will form the required H_d :

$$H_d(\tilde{\mathbf{x}}) = \frac{1}{2} \tilde{\mathbf{x}}^T \mathbf{D}^{-1} \tilde{\mathbf{x}} \quad (3)$$

where $\tilde{\mathbf{x}} = \mathbf{x} - \bar{\mathbf{x}}$ is the new state vector, defined as the difference between the state vector of the object \mathbf{x} and the desired vector $\bar{\mathbf{x}}$, which is the control task.

The structure of a closed-loop PBC system, which is a priori asymptotically stable, is described by the following equation [18]:

$$\dot{\tilde{\mathbf{x}}}(t) = [\mathbf{J}_d(\tilde{\mathbf{x}}) - \mathbf{R}_d(\tilde{\mathbf{x}})] \nabla H_d(\tilde{\mathbf{x}}), \quad (4)$$

where \mathbf{J}_d and \mathbf{R}_d are new matrices of interconnections and damping of the desired closed system, which consist of interconnections and damping of the control object and energy-forming passive control system: $\mathbf{J}_d = \mathbf{J} + \mathbf{J}_a$, $\mathbf{R}_d = \mathbf{R} + \mathbf{R}_a$.

To obtain the equation of a closed-loop controlled system in the form (4) for a given structure of control influences \mathbf{J}_a and \mathbf{R}_a , the necessary expressions of control influence formers (CIF), which are elements of the vector $\mathbf{u}(t)$, are obtained from the equality of the right parts of equations (2) and (4) by symbolic solution of the matrix equation [11]:

$$\dot{\mathbf{x}}(t) = [\mathbf{J}(\mathbf{x}) - \mathbf{R}(\mathbf{x})] \mathbf{D}^{-1} \mathbf{x} + \mathbf{G}(\mathbf{x}) \mathbf{u}(t) = [\mathbf{J}_d(\tilde{\mathbf{x}}) - \mathbf{R}_d(\tilde{\mathbf{x}})] \mathbf{D}^{-1} \tilde{\mathbf{x}} \quad (5)$$

THE PURPOSE OF THE ARTICLE

This work aims to synthesize control variants for a PBC system of a hybrid wind-solar power plant with a hybrid battery-supercapacitor energy storage system and to conduct a comparative analysis of the use of different CIF configurations for the synthesized system by computer simulation using MATLAB/Simulink.

To achieve this goal it is necessary to solve the following tasks:

- to develop a mathematical model of the studied system as a PCH system;
- to create Mathcad program for symbolic solution of matrix equation (5) for studied system, and obtain possible and available for practical implementation CIF structures;

- to develop a computer model of the studied electro generating complex in the MATLAB/Simulink environment;

- to investigate the effectiveness of individual elements of interconnections and damping included in the obtained structures of CIF;

- to conduct via computer simulation comparative studies of the system with different obtained structures of CIF and select the most effective of them.

MAIN PART. DESCRIPTION OF A HYBRID COMPLEX OF ELECTRICITY GENERATION AND ENERGY STORAGE

The object of control in this study is a power complex that combines two types of electric energy generation elements and two types of electric energy storage elements. The complex consists of a solar photovoltaic system PV, a wind power plant (which consist of a Windmill, a permanent magnet synchronous generator PMSM and a diode rectifier), a battery B, a supercapacitor modules SC and a Load (which consist of L-R circuit with a back EMF) connected to the DC bus capacitor C_{bus} (Fig. 1). These devices for generating and storing energy are

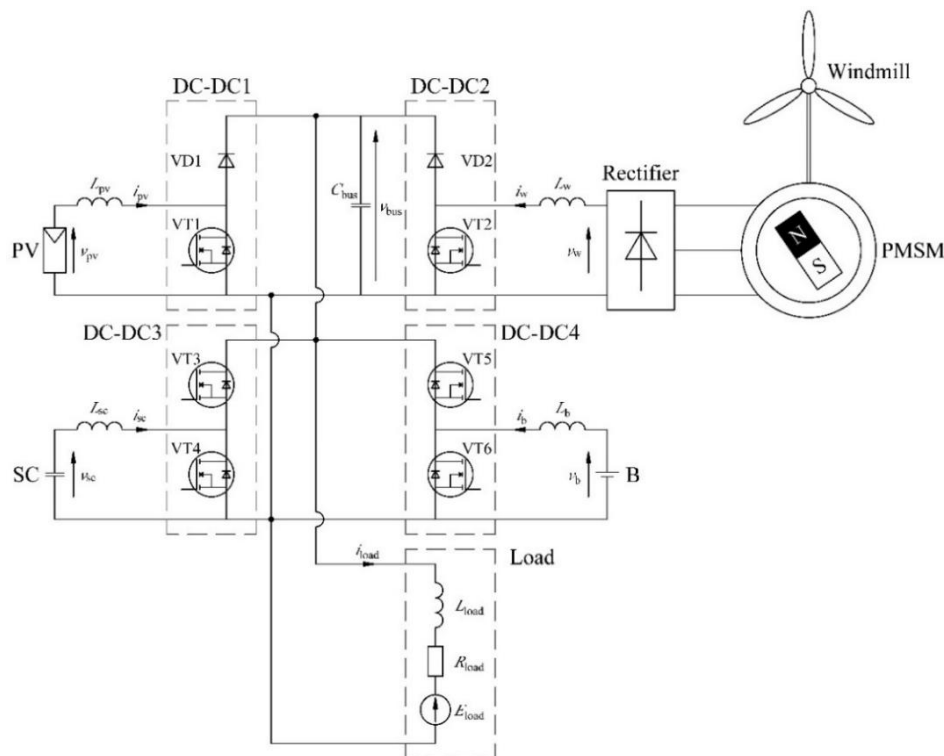

Fig. 1. Electrical diagram of the power part of the hybrid power complex with elements of generation and storage

Source: compiled by the authors

also connected to the DC bus, but through their power converters DC-DC1 – DC-DC4 of different topology. The photovoltaic system and the wind power plant are connected via unidirectional DC-DC converters of the step-up type, respectively DC-DC1 and DC-DC2, which carry out automatic control to ensure the operation of power plants at their maximum power points. The battery and SCM are connected via bidirectional DC-DC converters, DC-DC3 and DC-DC4, respectively, which allow using batteries and SCMs of lower voltage than required for the DC bus, and provide automatic regulation of charge and discharge currents in these energy storage devices.

As you can see, this hybrid power complex combines a number of devices, which even in individual use are quite complex objects. With the joint coordinated operation of these devices in the existing system, there are difficulties in the correct choice and application of the automatic control system and the creating of control effects on the object of control.

MATHEMATICAL MODELING OF THE STUDIED SYSTEM AS A PORT-CONTROLLED HAMILTONIAN SYSTEM

According to the electrical diagram (Fig. 1), the mathematical model of the control object, which describes its dynamics based on Kirchhoff's laws, will look like:

$$\left\{ \begin{aligned} L_b \frac{di_b}{dt} &= v_b - v_{bus} \gamma_b \\ L_{sc} \frac{di_{sc}}{dt} &= v_{sc} - v_{bus} \gamma_{sc} \\ C_{bus} \frac{dv_{bus}}{dt} &= i_b \gamma_b + i_{sc} \gamma_{sc} + i_{pv} \gamma_{pv} + i_w \gamma_w - i_l \\ C_{sc} \frac{dv_{sc}}{dt} &= -i_{sc} \\ L_l \frac{di_l}{dt} &= v_{bus} - E_l - R_l i_l \\ L_{pv} \frac{di_{pv}}{dt} &= v_{pv} - v_{bus} \gamma_{pv} \\ L_w \frac{di_w}{dt} &= v_w - v_{bus} \gamma_w \end{aligned} \right. , \quad (6)$$

where: $L_b, L_{sc}, L_l, L_{pv}, L_w$ are the inductances in the battery, SCM, load, solar and wind power plant, respectively; R_l is the load resistance; E_l is the back EMF of the load; $\gamma_b, \gamma_{sc}, \gamma_{pv}, \gamma_w$ are the coefficients of

duty cycle of DC-DC converters in the corresponding electric circuits (by analogy with inductors), and v_{bus} is the voltage on the DC bus supplied to the load.

Since the energy accumulators in such a system are the inductors in the load circuit, solar power plant, wind power plant, the battery and the SCM, as well as the capacitors, SCM and C_{bus} , it is advisable to choose the energy pulses of these drives as elements of the state vector [11]. Then the state vectors of the studied PCH system are obtained in the form:

$$\mathbf{x} = \begin{bmatrix} x_1 \\ x_2 \\ x_3 \\ x_4 \\ x_5 \\ x_6 \\ x_7 \end{bmatrix} = \begin{bmatrix} L_b i_b \\ L_{sc} i_{sc} \\ C_{bus} v_{bus} \\ C_{sc} v_{sc} \\ L_l i_l \\ L_{pv} i_{pv} \\ L_w i_w \end{bmatrix} = \mathbf{D} \begin{bmatrix} i_b \\ i_{sc} \\ v_{bus} \\ v_{sc} \\ i_l \\ i_{pv} \\ i_w \end{bmatrix}, \quad (7)$$

where $\mathbf{D} = \text{diag}[L_b \ L_{sc} \ C_{bus} \ C_{sc} \ L_l \ L_{pv} \ L_w]$ is the diagonal matrix of inertia of the system.

The other notations are clear from Fig. 1. The port matrix \mathbf{G} is the single diagonal matrix, and the input and output matrices have been obtained in the forms:

$$\mathbf{u} = \begin{bmatrix} v_b \\ 0 \\ 0 \\ 0 \\ -E_l \\ v_{pv} \\ v_w \end{bmatrix}; \quad \mathbf{y} = \begin{bmatrix} i_b \\ i_{sc} \\ v_{bus} \\ v_{sc} \\ i_l \\ i_{pv} \\ i_w \end{bmatrix}. \quad (8)$$

The Hamiltonian of the system taking into account the selected state vector \mathbf{x} and according to (1) will look like:

$$H(\mathbf{x}) = \frac{1}{2} \mathbf{x}^T \mathbf{D}^{-1} \mathbf{x} = \frac{1}{2} \left(\frac{1}{L_b} x_1^2 + \frac{1}{L_{sc}} x_2^2 + \frac{1}{C_{bus}} x_3^2 + \frac{1}{C_{sc}} x_4^2 + \frac{1}{L_l} x_5^2 + \frac{1}{L_{pv}} x_6^2 + \frac{1}{L_w} x_7^2 \right) \quad (9)$$

Then, the matrix of system interconnections will look like:

$$\mathbf{J}(\mathbf{x}) = \begin{bmatrix} 0 & 0 & -\gamma_b & 0 & 0 & 0 & 0 \\ 0 & 0 & -\gamma_{sc} & 1 & 0 & 0 & 0 \\ \gamma_b & \gamma_{sc} & 0 & 0 & -1 & \gamma_{pv} & \gamma_w \\ 0 & -1 & 0 & 0 & 0 & 0 & 0 \\ 0 & 0 & 1 & 0 & 0 & 0 & 0 \\ 0 & 0 & -\gamma_{pv} & 0 & 0 & 0 & 0 \\ 0 & 0 & -\gamma_w & 0 & 0 & 0 & 0 \end{bmatrix}. \quad (10)$$

The diagonal damping matrix $\mathbf{R}(\mathbf{x})$ of the system will have only one non-zero element, namely $R_{55} = R_1$.

THE SYNTHESIS OF PASSIVITY-BASED CONTROL SYSTEM

The main tasks of the synthesized control system, which together form the strategy of energy management (SEM), are as follows:

- maintaining the reference voltage of the DC bus at the level V_{bus}^* during changing power generation of solar and wind power plants, as well as load capacity;

$$\bar{\mathbf{x}} = \left[L_b \left(\frac{V_{bus}^* - E_1}{R_1} \cdot \frac{V_{bus}^*}{v_b} \right) \quad 0 \quad C V_{bus}^* \quad C_{sc} V_{sc}^* \quad L_1 \frac{V_{bus}^* - E_1}{R_1} \quad L_{pv} I_{pv} \quad L_w I_w \right]. \quad (11)$$

$$\mathbf{J}_a(\mathbf{x}) = \begin{bmatrix} 0 & j_{12} & j_{13} & j_{14} & j_{15} & j_{16} & j_{17} \\ -j_{12} & 0 & j_{23} & j_{24} & j_{25} & j_{26} & j_{27} \\ -j_{13} & -j_{23} & 0 & j_{34} & j_{35} & j_{36} & j_{37} \\ -j_{14} & -j_{24} & -j_{34} & 0 & j_{45} & j_{46} & j_{47} \\ -j_{15} & -j_{25} & -j_{35} & -j_{45} & 0 & j_{56} & j_{57} \\ -j_{16} & -j_{26} & -j_{36} & -j_{46} & -j_{56} & 0 & j_{67} \\ -j_{17} & -j_{27} & -j_{37} & -j_{47} & -j_{57} & -j_{67} & 0 \end{bmatrix}; \quad (12)$$

$$\mathbf{R}_a(\mathbf{x}) = \text{diag}[-r_{11} \quad -r_{22} \quad -r_{33} \quad -r_{44} \quad -r_{55} \quad -r_{66} \quad -r_{77}]. \quad (13)$$

- in the case of growth of the amount of energy generation or consumption by the Load and battery current achieving the maximum level of charge/discharge $\pm I_{b,max}^*$ – keeping this value at a given level; the remaining load power should be used by SCM, and after reducing the power on the load, the system should leave the limit.

Thus, according to the generated SEM, you can set the values of state variables at the desired equilibrium point as is shown in the vector (11), where I_{pv} and I_w are the currents of the solar plant and the output of the rectifier of the wind turbine, respectively, which act as perturbations in the system.

According to the principles of passive control by forming the desired interconnections and damping, we can form the complete matrices of the control system $\mathbf{J}_a(\mathbf{x})$ and $\mathbf{R}_a(\mathbf{x})$, respectively (12) and (13).

Based on the obtained mathematical model of the studied dynamic system (2), (7) - (10), it was created a program in the Mathcad environment that allows, using symbolic mathematics of this application, to solve the vector-matrix equation (5)

- formation of SCM charging/discharging processes in order to lead its voltage to a given value V_{sc}^* to provide random opportunities for energy absorption and return during significant changes in power generation or consumption;

- ensuring energy exchange between the battery and the DC voltage bus within the capacity corresponding to the specified value of the battery current $\pm I_{b,max}^*$, but the change in current should be slow (which will increase the lifetime of the battery), leaving the operation in rapid transients of the load change on the SCM;

for any combinations of given elements of matrices (12) and (13). If there is an analytical solution, we get the expressions CIF, which provide asymptotic stability of the whole system. These expressions are practically reduced to the control laws of DC-DC converters, namely, the duty cycle coefficients $\gamma_{pv}, \gamma_w, \gamma_b$, and γ_{sc} .

According to the results of computer studies of possible options for additional interconnection and damping, three fundamentally different CIF structures were synthesized: 1) without additional interconnections and damping; 2) with additional interconnection j_{23} and damping r_{11} ; 3) with additional interconnection j_{13} and damping r_{22} . The duty cycle coefficients of all DC-DC converters in these structures are given in Table 1.

As a result of research, the following effects of additional interconnections and damping introduced in the CIF were revealed and the following recommendations for their application were formed:

- r_{11} – improves voltage stabilization on the DC-bus v_{bus} at the desired level, as well as stabilizes and maintains the voltage on the SCM v_{sc} at the desired level, using more battery energy;

Table 1. CIF structures for three variants of passive control systems

	System 1 (without additional J and R)	System 2 ($j_{23}; r_{11}$)	System 3 ($j_{13}; r_{22}$)
γ_b	$\frac{v_b}{V_{bus}^*}$	$\frac{v_b - i_b r_{11} + I_b^* r_{11}}{V_{bus}^*}$	$\frac{v_b - v_{bus} j_{13} + V_{bus}^* j_{13}}{V_{bus}^*}$
γ_{sc}	$\frac{V_{sc}^*}{V_{bus}^*}$	$\frac{V_{sc}^* - v_{bus} j_{23} + V_{bus}^* j_{23}}{V_{bus}^*}$	$\frac{V_{sc}^* + i_{sc} r_{22}}{V_{bus}^*}$
γ_{pv}	$\frac{v_{pv}}{V_{bus}^*}$	$\frac{v_{pv}}{V_{bus}^*}$	$\frac{v_{pv}}{V_{bus}^*}$
γ_w	$\frac{v_w}{V_{bus}^*}$	$\frac{v_w}{V_{bus}^*}$	$\frac{v_w}{V_{bus}^*}$

Source: compiled by the authors

j_{23} – accelerates the transients, reduces energy consumption from the battery and increases its use from SCM to ensure the desired characteristics of the system;

j_{13} – affects the speed of the system, somewhat slowing down the transient voltage on the DC bus v_{bus} , increases the use of energy stored in the battery, and reduces the use of SCM energy;

r_{22} – improves the v_{sc} voltage stabilization at a given level, reducing the impact of the load on the system and using more SCM accumulated energy.

Disturbing factors that affect the system are changes in the intensity of solar radiation and fluctuations in wind speed (Fig. 3), as well as changes in load – the back EMF of the load branch (Fig. 6).

RESEARCH OF THE OBTAINED STRUCTURES OF CIF BY COMPUTER SIMULATION

In order to conduct comparative studies of the synthesized systems, in accordance with the electrical diagram shown in Fig. 1, a computer model (Fig. 2) is compiled in MATLAB/Simulink, which consists mainly of ready-made blocks of the SimScape library: PV Array simulates a solar electrical installation, Battery simulates battery operation, Supercapacitor simulates SCM operation. DC-DC converters operate in Average mode to reduce simulation time. The Wind Power Plant

subsystem simulates the operation of a wind turbine with a vertical axis of rotation, a synchronous generator with permanent magnets, and a diode bridge connected at its output. In the interval of relatively short simulation time, the average wind speed was chosen at the level of 10 m/s with slight fluctuations.

To study the operation of the passive system settings, a low-power system configuration was selected: solar photovoltaic panel 1Solitech 1STH-235-WH with a capacity of 235 W, wind turbine with a nominal power of 500 W at a wind speed of 11 m/s, lead-acid battery with a voltage of 24 V, rated with a capacity of 18 Ah and a state of charge (SOC) of 40 %, SCM is composed of 10 series-connected supercapacitors BCAP0650 from Maxwell with a capacity of 650 F and an internal series resistance of 0.8 mOhm.

The research was carried out according to the following parameters of the investigated installation, CIF control system, as well as reference signals: $L_b = L_{pv} = L_w = 5$ mH, $L_l = 1$ mH, $L_{sc} = 2$ uH, $C_{bus} = 3,3$ mF, $V_{bus}^* = 48$ V, $V_{sc}^* = 22$ V, $r_{11} = 0,005$, $j_{23} = 0,05$, $r_{22} = 0,03$, $j_{13} = 0,3$.

The simulation results in the form of time diagrams of the main coordinates of the system are shown in Fig. 3, Fig. 4, Fig. 5, Fig. 6, Fig.7, Fig. 8 and Fig.9.

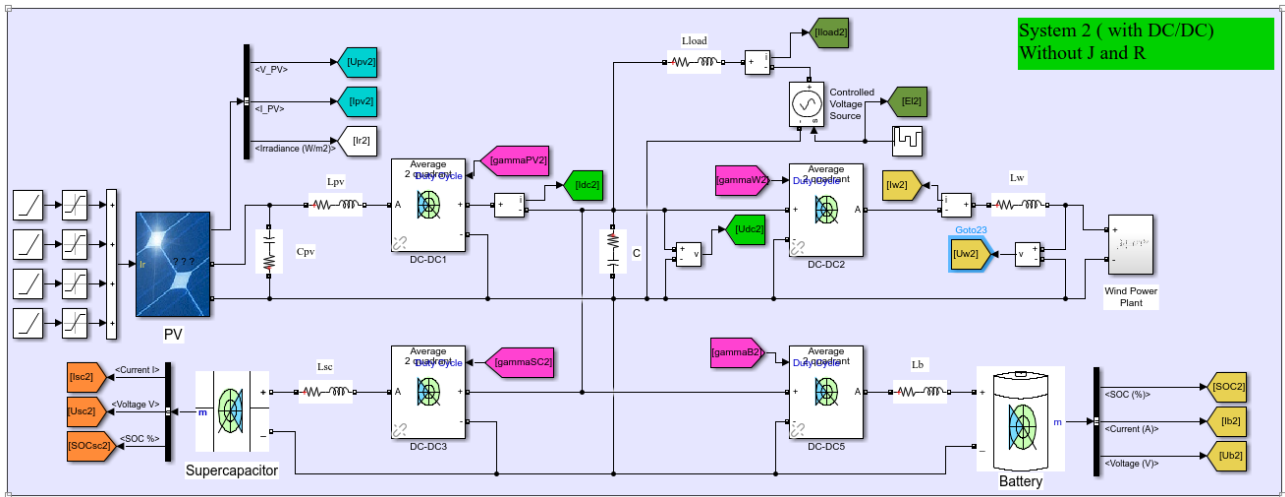

Fig. 2. Computer model of the investigated hybrid power plant with elements of energy generation and energy storage

Source: compiled by the authors

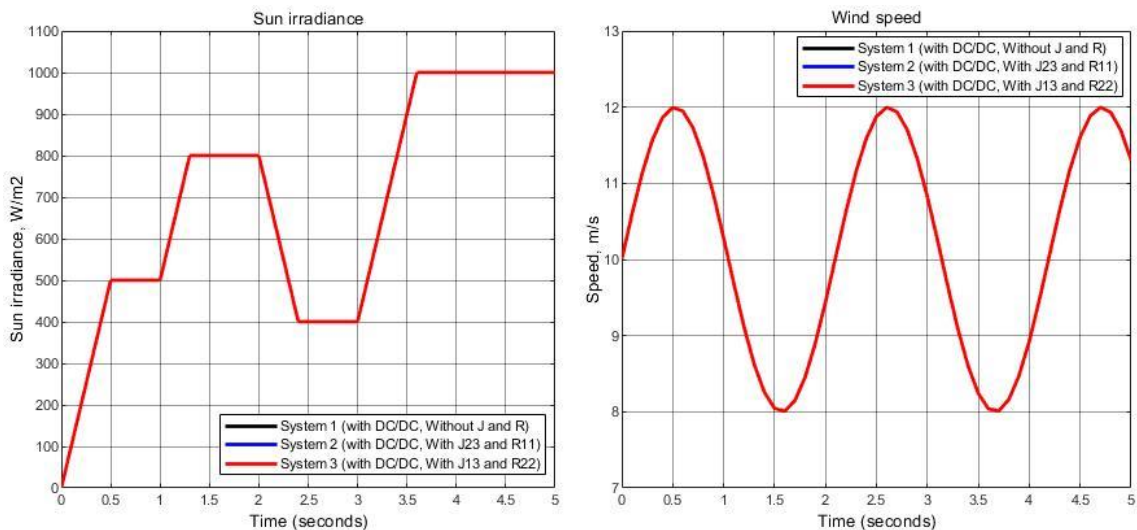

Fig. 3. Intensity of solar radiation and wind speed

Source: compiled by the authors

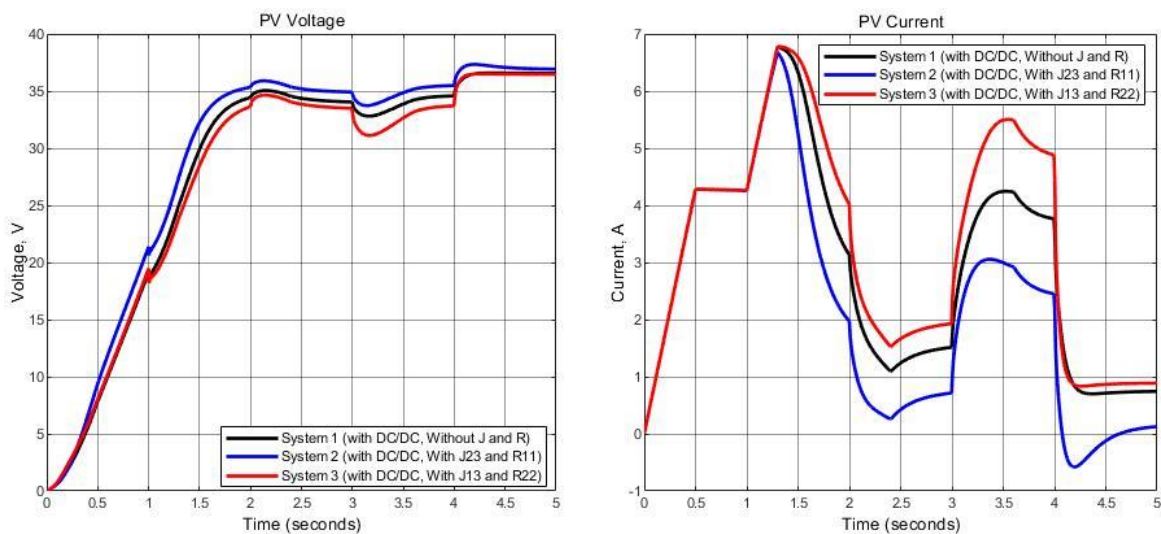

Fig. 4. Voltage and current of the solar power plant

Source: compiled by the authors

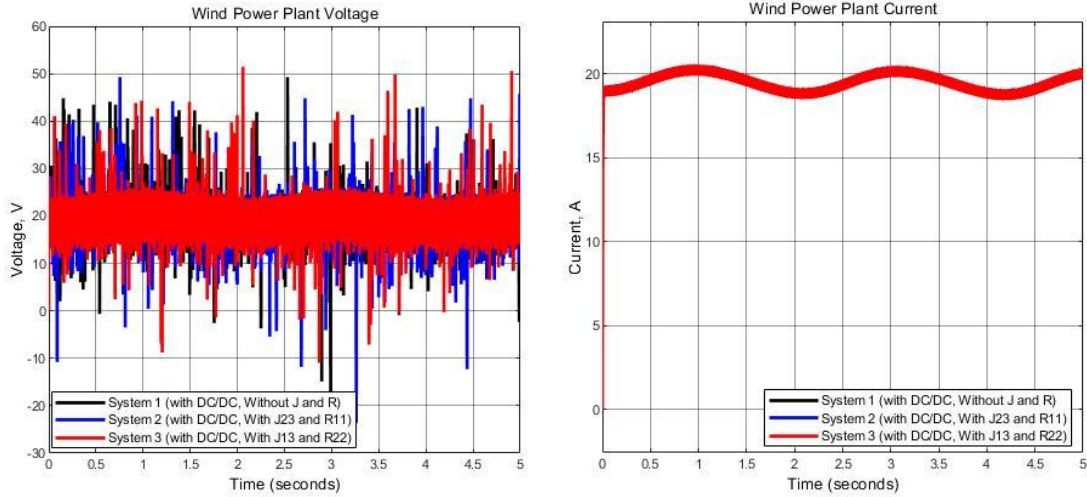

Fig. 5. Voltage and current at the output of the wind turbine rectifier

Source: compiled by the authors

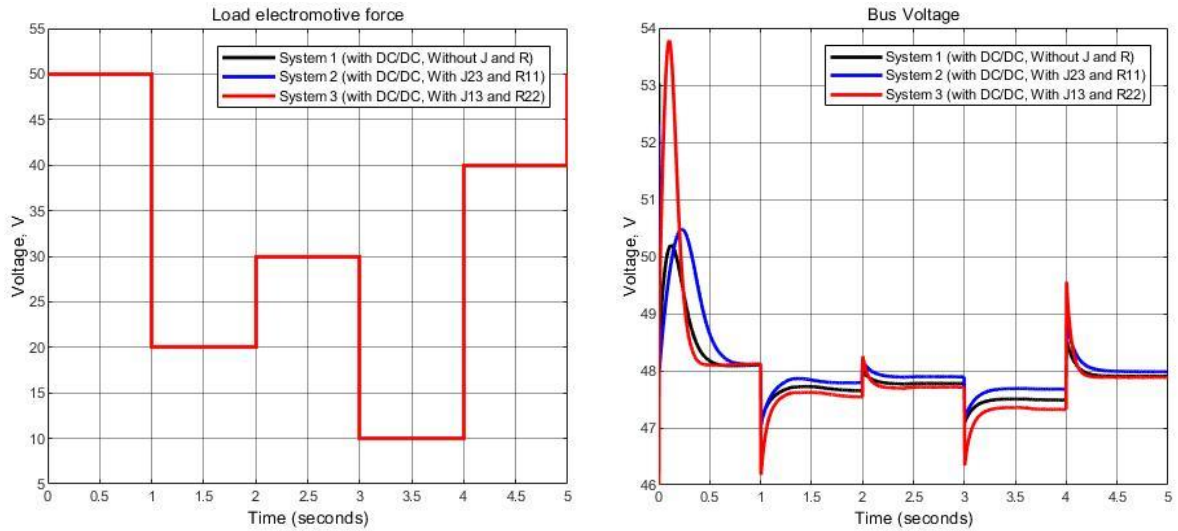

Fig. 6. Load back EMF and DC bus voltage

Source: compiled by the authors

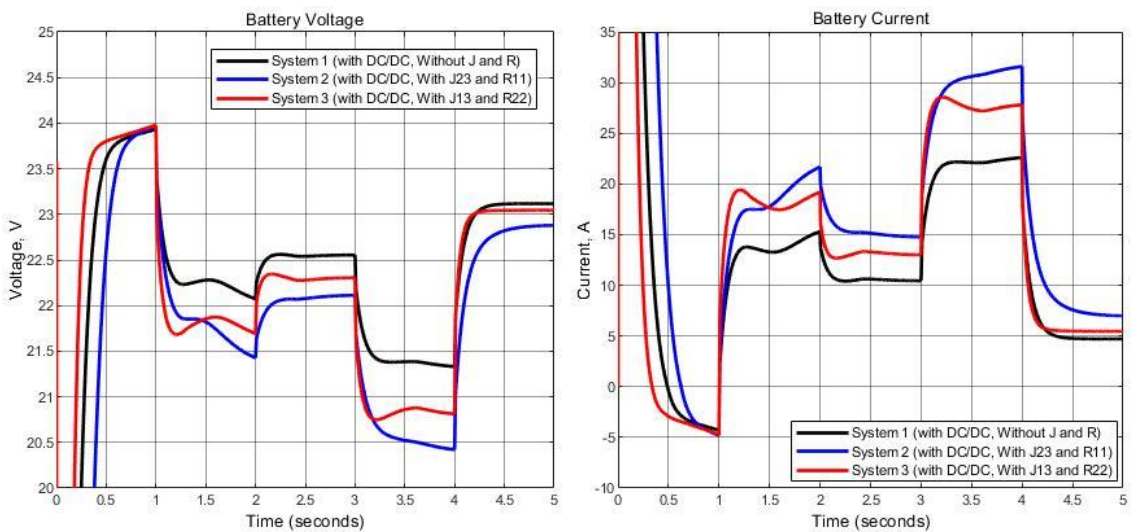

Fig. 7. Battery voltage and current

Source: compiled by the authors

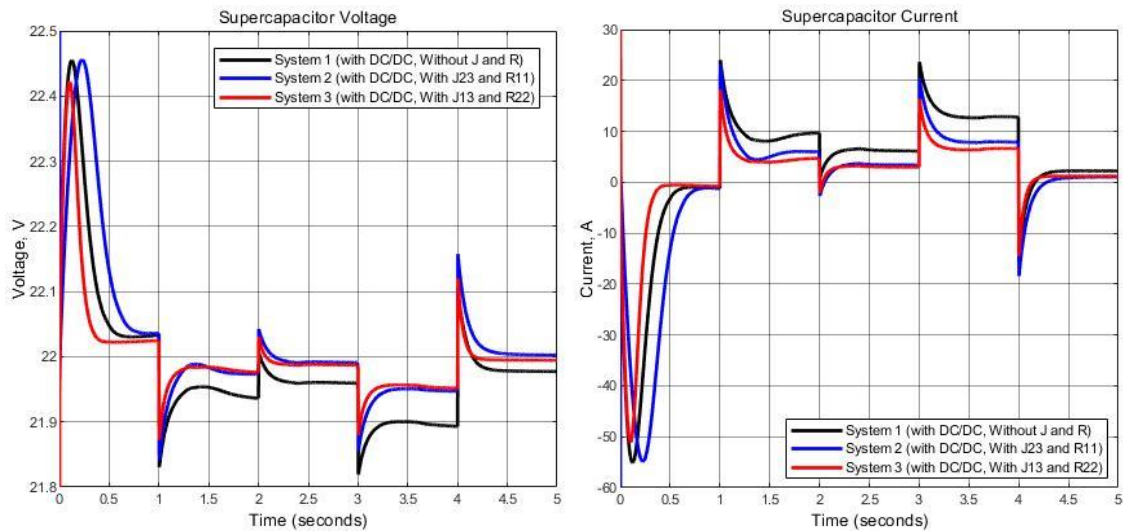

Fig. 8. Supercapacitor module voltage and current

Source: compiled by the authors

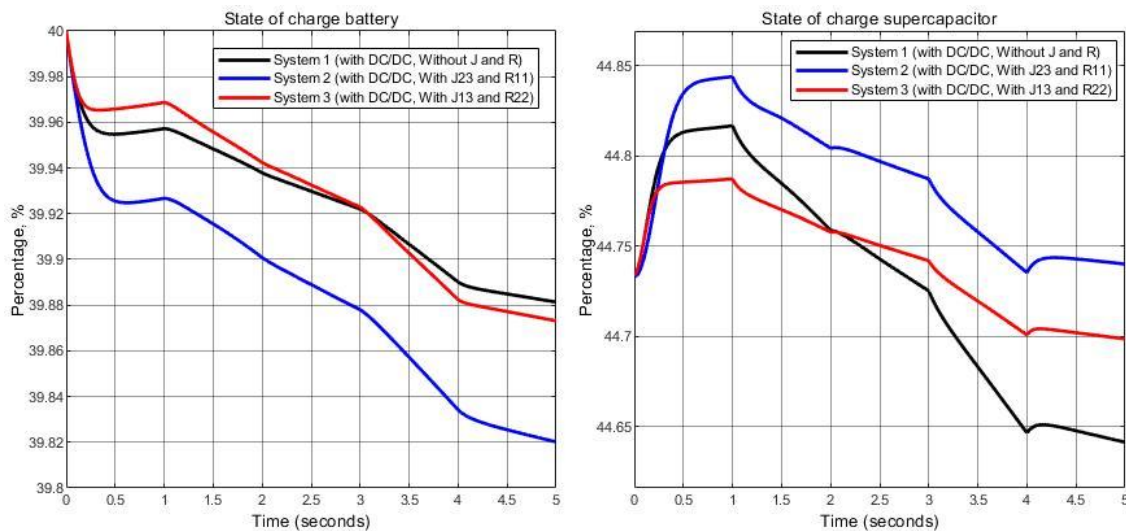

Fig. 9. SOC battery and supercapacitor module

Source: compiled by the authors

The results show that all three control systems generally perform according to SCM tasks: under the action of disturbances in the form of changes in the generated capacity of the solar panel (Fig. 4) and wind turbine (Fig. 5), as well as load (Fig. 6) support with a certain accuracy, the voltage on the DC bus at the level of 48 V (Fig. 6), and the voltage on the SCM at the level of 22 V (Fig. 8). In this case, the change in battery current under the action of perturbations occurs smoothly (Fig. 7), and rapid changes are covered by rapid changes in the SCM current at the beginning of the perturbations (Fig. 8). Introduction of additional interconnections in the system of passive control (“System 2” and “System 3” in comparison with “System 1”) positively influences quality of system work: errors of

regulation of voltages of DC bus and SCM in the established modes decrease, battery currents decrease and, accordingly, its SOC reducing is smaller (Fig. 9). “System 2” shows slightly better results compared to “System 1”. However, “System 1”, which has no additional interconnections and damping, which eliminates the need to adjust it, because the flow of energies occurs naturally, however, it ensures the operation according to reference signals at a sufficiently satisfactory level.

CONCLUSIONS

The use of a passivity-based control system with the formation of the desired interconnections and damping allows you to solve a range of problems of forming the desired static and dynamic

characteristics by controlling the energy flows in the system. The conducted researches allowed analyzing the possibilities of the passivity-based control system on the example of a rather complicated electric generation complex with a hybrid system of electric energy accumulation. The obtained results illustrate that synthesized CIFs work out the

reference signals with high enough accuracy, providing high-quality transients in the system. At the same time, with the help of the developed synthesis technique, it is possible to quickly obtain a number of CIF structures with different properties, to compare the efficiency of these structures by computer simulation and adjust their parameters.

REFERENCES

1. Cabrane, Z., Ouassaid, M. & Maaroufi, M. “Analysis and Evaluation of Battery-Supercapacitor Hybrid Energy Storage System for Photovoltaic Installation”. *Int. Journal of Hydrogen Energy*. 2016; Vol. 41: 20897–20907. DOI: <https://doi.org/10.1016/j.ijhydene.2016.06.141>.
2. Diaz-Gonzalez, F., Sumpera, A., Gomis-Bellmunt, O. & Villafafila-Robles, R. “A Review of Energy Storage Technology for wind Power Applications”. *Renewable and Sustainable Energy Reviews*. 2012; Vol. 16: 2154–2171. DOI: <https://doi.org/10.1016/j.rser.2012.01.029>.
3. Chong, W. T., Naghavi, M. S., Poh, S. C., Mahlia, T. M. I. & Pan K. C. “Techno-Economic Analysis of a Wind-Solar Hybrid Renewable Energy System with Rainwater Collection Feature for Urban High-Rise Application”. *Applied Energy*. 2011; Vol. 88: 4067–4077. DOI: <https://doi.org/10.1016/j.apenergy.2011.04.042>.
4. Ekren O. & Ekren B. “Size Optimization of a PV/Wind Hybrid Energy Conversion System with Battery Storage Using Simulated Annealing”. *Applied Energy*. 2010; Vol. 87: 592–598. DOI: <https://doi.org/10.1016/j.apenergy.2009.05.022>.
5. Sinchuk, O. N., Kozakevych, I. A. & Vornikov, D. N. “Control System of Wind Generator Based on Switched Reluctance Motor”. *Applied Aspects of Information Technology. Publ. Nauka i Tekhnika*. Odesa: Ukraine. 2019; Vol. 2 No. 3: 230–242. DOI: <https://doi.org/10.15276/aait.03.2019.5>.
6. Cabrane, Z., Ouassaid, M. & Maaroufi M. “Analysis and Evaluation of Battery-Supercapacitor Hybrid Energy Storage System for Photovoltaic Installation”. *Intern. Journal of Hydrogen Energy*. 2016; Vol. 41: 20897–20907. DOI: <https://doi.org/10.1016/j.ijhydene.2016.06.141>.
7. Ma, T., Yang, H. & Lu, L. “Development of Hybrid Battery–Supercapacitor Energy Storage for Remote area Renewable Energy Systems”. *Applied Energy*. 2015; Vol. 153: 56–62. DOI: <https://doi.org/10.1016/j.apenergy.2014.12.008>.
8. Ongaro, F., Saggini, S. & Mattavelli, P. “Li-Ion Battery-Supercapacitor Hybrid Storage System for a Long Lifetime, Photovoltaic-Based Wireless Sensor Network”. *IEEE Trans. Power Electron.* 2012; Vol. 27 No.9: 3944–3952. DOI: <https://doi.org/10.1109/TPEL.2012.2189022>.
9. Jing, W., Hung Lai, C., S. H. Wong, W. & M. L. Wong, D. “A Comprehensive Study of Battery-Supercapacitor Hybrid Energy Storage System for Standalone PV Power System in Rural Electrification”. *Applied Energy*. 2018; Vol. 224: 340–356. DOI: <https://doi.org/10.1016/j.apenergy.2018.04.106>.
10. Kollimalla, S. K., Mishra, M. K. & Narasamma, N. L. “Design and Analysis of Novel Control Strategy for Battery and Supercapacitor Storage System”. *IEEE Trans. Sustainable Energy*. 2014; Vol. 5 No.4: 1137–1144. DOI: <https://doi.org/10.1109/TSSTE.2014.2336896>.
11. Shchur, I. & Biletskyi, Y. “Enerhoformujuche keruvannia nelinejnyh elektromekhanichnyh systemamy z synkhronnymy mashynamy na postijnykh mahnitakh: monografija”. [Energy-Shaping Control of Nonlinear Electromechanical Systems with Permanent Magnet Synchronous Machines: Monograph] (in Ukrainian). Lviv: Ukraine. 2018. 174 p.
12. Wang, B., Xu, J., Xu, D. & Yan, Z. “Implementation of an Estimator-Based Adaptive Sliding Mode Control Strategy for a Boost Converter Based Battery/Supercapacitor Hybrid Energy Storage System in Electric Vehicles”. *Energy Conversion and Management*. 2017; Vol. 151: 562–572. DOI: <https://doi.org/10.1016/j.enconman.2017.09.007>.

13. Chong, L. W., Wong, Y. W., Rajkumar, R. K., Rajkumar, R. K. & Isa, D. “Hybrid Energy Storage Systems and Control Strategies for Stand-Alone Renewable Energy Power Systems, Renew. Sustain”. *Energy Review*. 2016; Vol. 6: 174–189. DOI: <https://doi.org/10.1016/j.rser.2016.07.059>.
14. Thounthong, P., Luksanasakul, A., Koseeyaporn, P. & Davat, B. “Intelligent Model-Based Control of a Standalone Photovoltaic/Fuel Cell Power Plant with Supercapacitor Energy Storage”. *IEEE Trans. Sustainable Energy*. 2013; Vol. 4 No. 1: 240–249. DOI: <https://doi.org/10.1109/TSTE.2012.2214794>.
15. Benaouadj, M., Aboubou, A., Ayad, M. Y. & Becherif, M. “Nonlinear Flatness Control Applied to Supercapacitor Contribution in Hybrid Power Systems Using Photovoltaic Source and Batteries”. *Energy Procedia*. 2014; Vol. 50: 333–341. DOI: <https://doi.org/10.1016/j.egypro.2014.06.040>.
16. Benaouadj, M., Aboubou, A., Ayad, M.Y. & Becherif, M. “Nonlinear Flatness Control Applied to Supercapacitor Contribution in Hybrid Power Systems Using Photovoltaic Source and Batteries”. *Energy Procedia*. 2014; Vol. 50: 333–341. DOI: <https://doi.org/10.1016/j.egypro.2014.06.040>.
17. Ortega, R., van der Schaft, A., Mareels, I. & Maschke, B. “Putting Energy Back in Control”. *IEEE Contr. Syst. Mag.* 2001; Vol. 21 No. 2: 18–33. DOI: <https://doi.org/10.1109/37.915398>.
18. Ortega, R., van der Schaft, A. J., Castanos, F. & Astolfi, A. “Control by Interconnection and Standart Passivity-Based Control of Port-Hamiltonian Systems”. *IEEE Contr. Syst. Tech.* 2008; Vol. 53 No. 11: 2527–2542. DOI: <https://doi.org/10.1109/TAC.2008.2006930>.
19. Nunna, K., Sassano, M. & Astolfi, A. “Constructive Interconnection and Damping Assignment for Port-Controlled Hamiltonian Systems”. *IEEE Trans. Autom. Control*. 2015; Vol. 60: 2350–2361. DOI: <https://doi.org/10.1109/TAC.2015.2400663>.
20. Benmouna, A., Becherif, M., Depature, C., Boulon, L. & Depernet D. “Experimental Study of Energy Management of FC/SC Hybrid System Using the Passivity Based Control”. *Int. J. of Hydrogen Energ.* 2018; Vol. 43 (25): 11583–11592. DOI: <https://doi.org/10.1016/j.ijhydene.2018.03.191>.
21. Benmouna, A., Becherif, M., Depernet, C. & Ebrahim, M. A. “Novel Energy Management Technique for Hybrid Electric Vehicle Via Interconnection and Damping Assignment Passivity Based Control”. *Renewable Energy*. 2018; Vol. 119: 116–128. DOI: <https://doi.org/10.1016/j.renene.2017.11.051>.
22. Yang, D., Wang, J., Xiang, H. & Ma, Y. “Research on Passivity-Based Power Control of Direct-Driven Wind Power System Dual-PWM Converter”. *2012 IEEE 7th Int. Power Electronics and Motion Control Conf. – ECCE Asia*. Harbin: China. June 2-5, 2012. p. 841–845. DOI: <https://doi.org/10.1109/IPEMC.2012.6258955>.
23. Shchur, I., Rusek, A. & Biletskyi, Y. “Energy-Shaping Optimal Load Control of PMSG in a Stand-Alone Wind Turbine as a Port-Controlled Hamiltonian System”. *Przegląd Elektrotechniczny (Electrical review)*. 2014; No. 5: 50–55. DOI: <https://doi.org/10.12915/pe.2014.05.10>.
24. Shchur, I. & Biletskyi, Y. “Battery Current Limitation in Passivity-Based Controlled Battery/Supercapacitor Hybrid Energy Storage System”. *Proc. 38th IEEE Int. Conf. on Electronics and Nanotechnology (ELNANO-2018)*. Kyiv: Ukraine. 2018. p. 504–510. DOI: <https://doi.org/10.1109/ELNANO.2018.8477477>.
25. Biletskyi, Y., Kuzyk, P.-I. & Lompart, Y. “Syntez ta analiz systemy enerhoformujuchoho keruvannia vitrosoniachnoju ustanovkoju z hibrydnoju systemoju nakopychennia enerhii” [Synthesis and Analysis of the Energy-Shaping Control System of a Wind-Solar Power Plant with a Hybrid Energy Storage System] (in Ukrainian). *Electrical Power and Elektromechanical Systems*. 2020; Vol.2 No. 1: 8–17. DOI: <https://doi.org/10.23939/sepes2020.01.008>.
26. Shchur, I. & Biletskyi, Y. “Interconnection and Damping Assignment Passivity Based Control of Semi-Active and Active Battery-Supercapacitor Hybrid Energy Storage Systems for Stand-Alone Photovoltaic Installations”. *Proc. 14th IEEE Int. Conf. on Advanced Trends in Radioelectronics, Telecommunications and Computer Engineering (TCSET-2018)*. Lviv: Ukraine. 2018. p. 1–6. DOI: <https://doi.org/10.1109/TCSET.2018.8336212>.
27. Kuzyk, R.-I. & Biletskyi, Y. “Energy-Shaping Control of the Wind-Solar Power Plant with a Hybrid Energy Storage System”. *Proc. of the 9th Int. Conf. of Young Scientists EPECS-2019*. Electronic Edition on CD-ROM. 2019. p. 84–89.

28. Shchur, I. & Biletskyi, Y. "Improved Structure of Passivity-based Control of Battery-Supercapacitor Hybrid Energy Storage System". *Applied Aspects of Information Technology. Publ. Nauka i Tekhnika*. Odesa: Ukraine. 2020; Vol. 3 No. 4: 232–245. DOI: <https://doi.org/10.15276/aait.04.2020.2>.

29. R. Ortega, A.J. van der Schaft, G. Escobar & Maschke B. "Interconnection and Damping Assignment Passivity-Based Control of Port-Controlled Hamiltonian Systems". *Automatica*. 2002; Vol. 38: 585–596. DOI: [https://doi.org/10.1016/S0005-1098\(01\)00278-3](https://doi.org/10.1016/S0005-1098(01)00278-3).

Conflicts of Interest: the authors declare no conflict of interest

Received 21.12.2020

Received after revision 10.02.2021

Accepted 16.03.2021

DOI: <https://doi.org/10.15276/aait.02.2021.2>

УДК 685.511 + 62-83

СИСТЕМА ЕНЕРГОФОРМУЮЧОГО КЕРУВАННЯ АВТОНОМНИМ ГІБРИДНИМ ЕЛЕКТРОГЕНЕРУЮЧИМ КОМПЛЕКСОМ

Юрій Олегович Білецький¹⁾

ORCID: <https://orcid.org/0000-0001-6988-0825>; yurii.o.biletskyi@lpnu.ua. Scopus ID: 56470782400

Ігор Зенонович Щур¹⁾

ORCID: <https://orcid.org/0000-0001-7346-1463>; ihor.z.shchur@lpnu.ua. Scopus ID: 36348908300

Ростислав-Іван В. Кузик¹⁾

ORCID: <https://orcid.org/0000-0002-6483-2223>; rostyslav-ivan.kuzyk.mnee.2019@lpnu.ua

¹⁾ Національний університет «Львівська політехніка», вул. С. Бандери, 12. Львів, 79013, Україна

АНОТАЦІЯ

Прагнення енергетичної незалежності зумовлює використання різного типу елементів генерування енергії з відновлюваних джерел, для роботи яких в автономному режимі необхідні пристрої накопичення енергії. Створений таким чином електрогенеруючий комплекс повинен виконувати низку завдань, які формуються системою енергетичного менеджменту. Виконання цих завдань та забезпечення належних статичних і динамічних характеристик роботи цього комплексу з багатьма входами і виходами здійснює система керування. Як показують результати останніх досліджень у світі, а також досвід авторів цієї роботи, для побудови подібних систем керування доцільно застосувати пасивне керування (Passivity-Based Control – PBC), представивши об'єкт керування як гамільтонову систему з керованими портами (Port-Controlled Hamiltonian System - PHS). Завдяки розробленому методу введення додаткових взаємозв'язків та демпфування (Interconnection & Damping Assignment – IDA) пасивне керування дає широкі можливості для налаштувань керуючих впливів, забезпечуючи при цьому асимптотичну стійкість системи в цілому. Це особливо корисно у складній системі, що розглядається в даній роботі і включає в себе як гібридну енергоустановку генерування електроенергії від сонця і вітру, так і гібридну установку накопичення енергії в акумуляторній батареї та суперконденсаторному модулі. У даній статті показано процедуру синтезу системи пасивного керування, за якою сформовано та досліджено три структури формувачів керуючих впливів (ФКВ) з різними комбінаціями додатково введених взаємозв'язків та демпфувань, що дає можливість сформувати бажані перетікання енергії в середині замкненої системи, а отже і забезпечити бажані результати керування. Серед них, зокрема, є завдання підтримання напруг на шині мережі постійного струму та суперконденсаторному модулі на заданих рівнях, плавність перехідних процесів струму в акумуляторній батареї. Проведено порівняльні симуляційні дослідження на створеній в середовищі Matlab/Simulink комп'ютерній моделі електрогенеруючого комплексу з використанням синтезованих систем керування, які показали ефективність їх роботи та переваги різних структур ФКВ.

Ключові слова: Електрогенеруючий комплекс; сонячна електроустановка; вітрова енергоустановка; гібридна акумуляторно-суперконденсаторна система нагромадження енергії; пасивне керування (PBC); гамільтонова система з керованими портами (PHS); синтез взаємозв'язків і демпфування (IDA)

ABOUT THE AUTHORS

Yurii Olegovych Biletskyi – PhD (Eng), Assistance Professor of the Department of Electromechanics and Computerized Electromechanical Systems, Lviv Polytechnic National University, 12, S. Bandery Str. Lviv, 79013, Ukraine

ORCID: <https://orcid.org/0000-0001-6988-0825>; yurii.o.biletskyi@lpnu.ua

Research field: Nonlinear Control Theory; Energy-Based Control System Synthesis; Renewable Energy Sources; Modelling of Electromechanical and Electrotechnical Systems

Юрій Олегович Білецький – кандидат технічних наук, доцент кафедри Електромехатроніки та комп'ютеризованих електромеханічних систем Національного університету «Львівська політехніка», вул. С. Бандери, 12. Львів, 73013, Україна



Ihor Zenonovich Shchur – Dr. Sci. (Eng), Professor, Head of Department of the Electromechanics and Computerized Electromechanical Systems, Lviv Polytechnic National University, 12, S. Bandery Str. Lviv, 79013, Ukraine

ORCID: <https://orcid.org/0000-0001-7346-1463>; ihor.z.shchur@lpnu.ua

Research field: Control Systems of Vehicle Electric Drive; Renewable Energy; Energy Storage Systems; Energy-Based Mathematical Modelling and Synthesis of Control Systems

Ігор Зенонович Щур – доктор технічних наук, професор, зав. каф. Електромехатроніки і комп'ютеризованих електромеханічних систем Національного університету «Львівська політехніка», вул. С. Бандери, 12. Львів, 73013, Україна



Rostyslav-Ivan Kuzyk, Graduate Student of Department of the Electromechanics and Computerized Electromechanical Systems, Lviv Polytechnic National University, 12, S. Bandery Str. Lviv, 79013, Ukraine

ORCID: <https://orcid.org/0000-0002-6483-2223>; rostyslav-ivan.kuzyk.mnee.2019@lpnu.ua

Research field: Nonlinear Control Theory; Energy-Based Control System Synthesis; Renewable Energy Sources

Ростислав-Іван Кузик, студент кафедри Електромехатроніки і комп'ютеризованих електромеханічних систем Національного університету «Львівська політехніка», вул. С. Бандери, 12. Львів, 73013, Україна