



Multidimensional Simulation of Speed Controlled Induction Electric Drives with Matching Reducers and Transformers

Viktor Petrushin, Vladimir Vodichev, and Rostislav Yenoktaiev

Institute of Electromechanics and Energy Management of Odessa National Polytechnic University, Odessa, Ukraine

viktor_petrushin@ukr.net, vva@eei.opu.ua, rostik-enok@inbox.ru

Abstract: Operation of different induction motors as a part of controlled - speed electric drives, which carry out the same engineering problem, taking into account turning on of such devices as the transformer and the reducer is examined. A variability of parameters of equivalent circuits of the motors, linked with a modification of magnitudes and frequencies of voltage feeding the motors, and also with saturation of magnetic circuits and displacement of currents in windings of rotors is considered. Comparison of motors characteristics in static and dynamic regimes is carried out. Energy, weight, size and cost parameters are defined. The possibility of sampling of the best alternative of the drive, both on the above-stated indexes, and at cost of losses of active energy is justified. Modelling of a thermal state of motors in static and dynamic regimes is carried out. The analysis of vibroacoustic performance of the motors is made at operation in the certain circuit design of the electric drive on the given control range: vibrational velocity and vibrational acceleration of a magnetic origin, vibrational velocity of a mechanical origin (the radial and axial), ventilating and magnetic noise. Mechanical indexes (rigidity of the shaft, strength of the shaft and dynamic weightlifting capacity of the bearing), characterizing a mechanical state of an induction motor are observed and compared.

Keywords: the induction electric drive, an speed-controlled induction motor, the reducer, the transformer

1. Introduction

Using of the controlled-speed electric drive (CED) in all industries and on a transport allows rationally control technological processes at minimization of consumption of energy resources. A variety of systems of induction CED are characterized by including in them of such devices as reducers and transformers, and last can be switched on not only on an entry, but also on an exit of the frequency converter. Using of these devices considerably changes operating characteristics of the CED. The majority of papers is devoted to modelling of the CED without such devices both in static and in dynamic regimes [1,2,3,4,5]. It is expedient to model operations of the CED including these devices.

2. Statement of problem

For shaping of models of matching transformers and reducers it is necessary to introduce a row of the initial data defining both functional properties, and mass, weight, dimensional and cost indexes. Last give the chance to observe economic aspects of the CED. The functional properties are: for the reducer - a gear ratio (i_{red}), for the transformer - a transformation ratio (k_{tr}). For correctness of energy balance of the electric drive calculation using of efficiency factor is required (η_{red} , η_{tr}).

Taking into account in the simulation reducers and transformers in static and dynamic regimes a rotational speed (n_{mech}), the torque on the drive mechanism (M_{mech}), power consumed by the drive (P_{CED}), efficiency of the drive (η_{CED}), power of the mechanism (P_{mech}) are defined. Besides, it is obviously possible to count weight, dimensions and cost parameters of all the CED at use of those or other considered components.

Received: June 27th, 2015. Accepted: May 13rd, 2016

DOI: 10.15676/ijeei.2016.8.2.3

The expressions considering using of the reducer and the transformer in the CED by consideration of a static conditions, look like:

$$n_{mech} = \frac{n}{i_{red}}, \quad M_{mech} = M_m \cdot i_{red} \cdot \eta_{red}, \quad (1)$$

$$P_{CED} = P_1 + (1 - \eta_c) \cdot P_1 + (1 - \eta_{red}) \cdot P_1 + (1 - \eta_{tr}) \cdot P_1, \quad (2)$$

$$P_{mech} = P_m \cdot \eta_{red}, \quad \eta_{CED} = \eta_m \cdot \eta_c \cdot \eta_{red} \cdot \eta_{tr}, \quad (3)$$

$$i_1(t) = \sqrt{\frac{1}{2} \cdot [i_{sa}(t)^2 + i_{s\beta}(t)^2]}, \quad (4)$$

Where M_m - the torque on the motor shaft; P_m - the useful mechanical power on the shaft of the motor; P_1 - a consumed active power of the motor; η_c - efficiency of the motor; η_c - efficiency of the converter; U_1 - primary voltage of the transformer; U_2 - secondary voltage of the transformer.

The mathematical models (MM) used for examination of the transitive electromagnetic and electromechanical processes in controlled induction motors, are grounded on systems of nonlinear differential equations of equilibrium of voltage and currents in system of converted coordinates[6,7,8,9].

$$\frac{d}{dt} \Psi_{sa} = u_{sa}(t) - r_s d(t) [x_r(t) \Psi_{sa}(t) - x_M(t) \Psi_{ra}(t)], \quad (5)$$

$$\frac{d}{dt} \Psi_{s\beta} = u_{s\beta}(t) - r_s d(t) [x_r(t) \Psi_{s\beta}(t) - x_M(t) \Psi_{r\beta}(t)], \quad (6)$$

$$\frac{d}{dt} \Psi_{ra} = [-p\omega_r \cdot i_{ped} \Psi_{r\beta}(t) - r_r(t) d(t) [x_s(t) \Psi_{ra}(t) - x_M(t) \Psi_{sa}(t)], \quad (7)$$

$$\frac{d}{dt} \Psi_{r\beta} = [p\omega_r \cdot i_{ped} \Psi_{r\beta}(t) - r_r(t) d(t) [x_s(t) \Psi_{r\beta}(t) - x_M(t) \Psi_{s\beta}(t)], \quad (8)$$

$$\frac{d\omega_r}{dt} = \frac{1}{J} \left\{ \frac{3p}{2} d(t) x_M(t) [\Psi_{s\beta}(t) \Psi_{ra}(t) - \Psi_{r\beta}(t) \Psi_{sa}(t)] - M_c(\omega_r) \cdot \eta_{ped} \right\}, \quad (9)$$

Where $\Psi_{sa}(t)$, $\Psi_{s\beta}(t)$, $\Psi_{ra}(t)$, $\Psi_{r\beta}(t)$ – magnetic flux linkages of the stator and rotor windings of the motor, accordingly on axes α and β ; ω_r – an angular speed of the mechanism; p – poles pairs number; J – the total moment of inertia of the drive reduced to the shaft of the motor; $M_c(\omega_r)$ – dependence of a moment of resistance of the mechanism on an angular speed; r_s , $r_r(t)$, $x_s(t)$, $x_r(t)$, $x_M(t)$ – active and total reactive resistances of windings of the stator and rotor and resistance of a mutual induction, and all of them, behind exclusion r_s , vary on each integration step; $d(t)$ – an auxiliary variable $d(t) = [x_s(t) \cdot x_r(t) - (x_M(t))^2]^{-1}$; $u_{sa}(t)$, $u_{s\beta}(t)$ – instantaneous values of voltage on axes α and β which are defined by peak voltage U_m (depending on the law of the frequency control) and an angular position of the generalised voltage vector φ_1

$$u_{sa}(t) = U_m(t) \cdot \cos(\varphi_1), \quad u_{s\beta}(t) = U_m(t) \cdot \sin(\varphi_1), \quad (10)$$

thus the system is supplemented with two more differential equations

$$\frac{d}{dt} \varphi_1 = \omega_1 \quad \text{и} \quad \frac{d}{dt} \omega_1 = \varepsilon_1(t), \quad (11)$$

Where ω_1 – angular speed, $\varepsilon(t)$ – the dependence in time of angular accelerations of the generalised voltage vector, defined with a drive velocity diagram.

The expressions linking instantaneous values of currents and magnetic linkages, look like the following:

$$\begin{aligned} i_{s\alpha}(t) &= d(t) \cdot [x_r(t) \cdot \Psi_{s\alpha}(t) - x_M(t) \cdot \Psi_{r\alpha}(t)], \\ i_{s\beta}(t) &= d(t) \cdot [x_r(t) \cdot \Psi_{s\beta}(t) - x_M(t) \cdot \Psi_{r\beta}(t)], \end{aligned} \quad (12)$$

Where $i_{s\alpha}$, $i_{s\beta}$ – stator currents on axes α and β . The root-mean-square current of the stator

$$i_1(t) = \sqrt{\frac{1}{2} \cdot [i_{s\alpha}(t)^2 + i_{s\beta}(t)^2]}, \quad (13)$$

A mathematical model constructed on the basis of the above describer differential equations, allows calculating of rotation speed, currents in the phases windings, electromagnetic torques, power losses.

In each of the equations take place non-linear coefficients such as engine parameters varying in each operating point, including due to saturation phenomena of the magnetic system and the displacement current in the rotor winding [10]. One of the approaches to dynamic characteristics of controlled induction motors analysis involves a preliminary determination of these coefficients for the required operating point of the control range. Therefore, to analyse the transient mode steady-state modes calculations are carried out in order to obtain the values of all the equivalent circuit parameters taking into account current displacement in the rotor winding and the magnetic saturation for the required operating point of the control range. MM of steady runs for this purpose are used. In the calculations of dynamic modes changes in each step of the integration of the system are taken into account, i.e. at certain points, the transition from one speed to another, the magnitude and frequency of the supply voltage in accordance with the used law of frequency regulation, equivalent circuit parameters. During the loads of fan and pulling type the load torque also changes, the value of which, corresponding to the angular rotation frequency is determined by the load characteristic. Improving of the adequacy of MM is provided by implementing of this approach.

The conventional active power consumed by the motor in dynamic regimes under condition of a sinusoidal supply voltage can be calculated through virtual values of voltage and currents

$$P_1' = \frac{3}{2} \cdot [U_{s\alpha} \cdot I_{s\alpha} + U_{s\beta} \cdot I_{s\beta}] \quad (14)$$

Real consumed active power P_1 more than the conventional total on magnitude of not considered losses (in a magnetic circuit, additional, mechanical)

$$P_1 = P_1' + \Delta P_{st\ base} + \Delta P_{st\ add} + \Delta P_{mech} + \Delta P_{add}. \quad (15)$$

Shaft power of the motor can be defined through magnetic linkages and currents with use of meaning of a rotational speed of a rotor

$$P_2 = \omega_r \frac{3p}{2} [I_{r\beta} \Psi_{r\alpha} - I_{r\alpha} \Psi_{r\beta}] - \Delta P_{mech} - \Delta P_{extra} \quad (16)$$

The efficiency instantaneous value is defined by a ratio of instantaneous values of useful power on the shaft of the motor P_2 to consumed active power P_1 .

3. The results of investigation

During the modelling of the CED according to system approach principles joint consideration of transformers, motors and loadings, and also reducers and matching transformers [11] is necessary. On department of electrical machines of the Odessa national polytechnic university software product DIMASDrive [12] is developed, allowing to realise such model operation.

The CED with the transistor frequency converter with the autonomous inverter of voltage and pulse– width regulating further is observed. The law of the frequency control $U/f = \text{const}$ was observed. Reviewed the draft load with the power of $P_{load} = 35 \text{ kW}$ with a peak torque $1500 \text{ N}\cdot\text{m}$. At the given stationary magnitude of a loading, a demanded control range (30-250 rpm) in systems of the CED can be ensured by different motors, under condition of using of reducers and transformers.

Three alternatives of the CED are observed at voltage of the main 400 V and a frequency of 60 Hz.

For direct- drive CED (Figure 1) is chosen the motor 4A355M12, working with the frequency converter (Mitsubishi FR-A 540 L-G EC, 75 kg, $\eta_c=0.98$) [13].

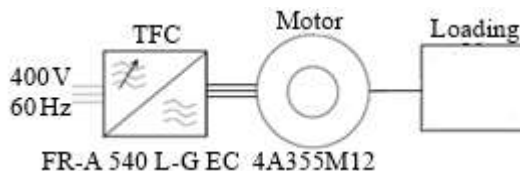

Figure 1. The block diagram of the direct-drive CED

For the CED with the reducer (Figure 2) is chosen the motor 4A250M4, working with the frequency converter (Mitsubishi FR-A 540 L-G EC, 75 kg, $\eta_c=0.98$) and the reducer (1I2Y200, 135 kg, $\eta_{red}=0.98$, $i_{red}=6.3$) [13,14].

For the CED with the transformer and the reducer (Figure 3) are chosen the motor 4A200L4, the step- up transformer (510 kg, $\eta_{tr}=0.98$, $k_{tr}=0.8$), the reducer (1I2Y-200, 170 kg, $\eta_{red}=0.98$, $i_{red}=10$) and the transistor frequency converter (Mitsubishi FR-A 540 EC, 35 kg, $\eta_c=0.98$) [13,14,15].

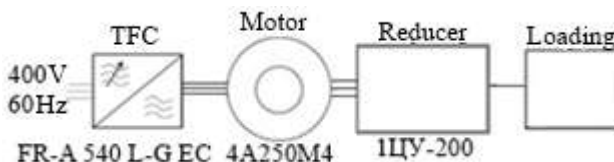

Figure 2. The block diagram of the CED with the reducer

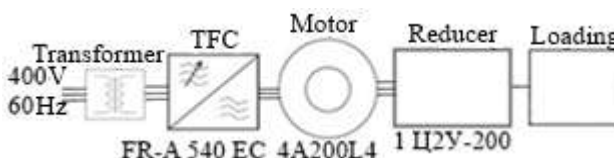

Figure 3. The block diagram of the CED with the reducer and the transformer

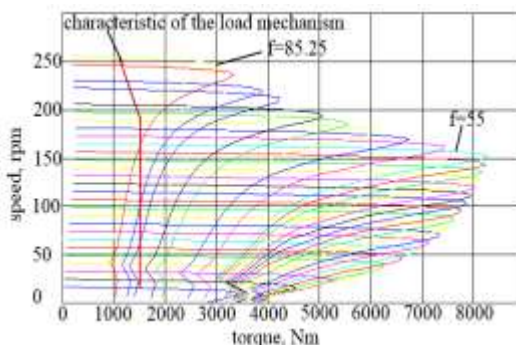

Figure 4. A set of speed-torque characteristics

The adjusting characteristics representing dependences of a variation of electrical, energy and thermal magnitudes from a rotating speed, can be gained at use of characteristic families, including mechanical, at various parameters of regulating on which characteristics of the load mechanism are superimposed. On Figure 4 the set of speed- torque characteristics and the given loading, matching to the block diagram figured on Figure 3 is presented.

At such combination of speed-torque characteristics and loadings it is observed three bands which are manifested on character of adjusting characteristics. Within each band the uniform modification of speed-torque characteristics and a load line occurs.

On Figure 5, Figure 6 and Figure 7 adjusting characteristics of observed CED are presented.

The analysis of a thermal state of an induction motor is one of the major problems at examinations of any system the CED. To the problems linked with the analysis of a thermal state of an induction motor and heat calculations, numerous papers [16, 17, 18, 19, 20, 21, 22] are devoted.

The thermal state of an induction motor defines level of its operate reliability. The admissible reheat temperature is restricted to a class of thermal classification of applied insulations. The majority of premature fallings out of an induction motor is called by an accelerated ageing of isolation of a winding of the stator owing to excessive heating. This problem is especially actual for the induction motors operated in the CED as additional excessive heating is caused

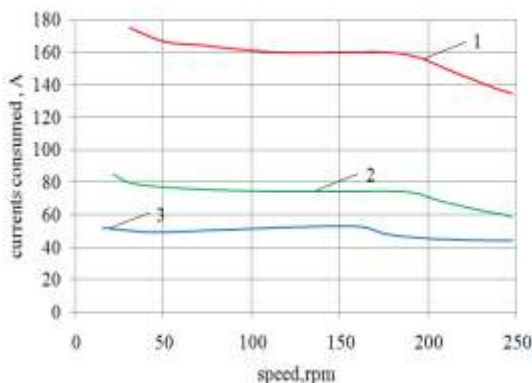

Figure 5. A modification of currents consumed by motors over the speed range: 1 CED without the reducer, 2 CED with the reducer, 3 CED with the reducer and the transformer

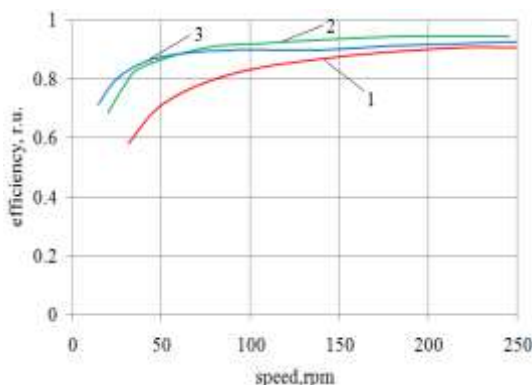

Figure 6. Performances of efficiency of motors over the speed range: 1 CED without the reducer, 2 CED with the reducer, 3 CED with the reducer and the transformer

by magnification of losses because of no sinusoidal current, and also a decline of a tap of heat to an environment at lowering of a rotational speed of motors with a self-ventilation. Heating of a concrete induction motor depends on ambient conditions, magnitude of losses in its constructional devices, intensity of an abstracted heat from these devices. The magnitude of the energy loss and intensity of cooling of controlled induction motors define such operation and technology factors:

- The aspect and parameters of the load mechanism (dependence of a torque of resistance on velocity and a moment of inertia of mechanism) define level of load and accordingly a degree of losses in the motor on a various rotational speed.
- Mode of operation S1 - S8.
- Modification of the electrical machine (enclosed, protected, unclosed), ventilation system (axial, the radial, immixed), a cooling aspect (independent, self-cooling), defining intensity of heat removal from motor to an environment.

At an induction motor heat calculation should be considered not only a modification of magnitude of a loading, but also parameters of the voltage feeding the motor gained from the semiconductor convertor (SC) (frequencies, magnitudes, a spectral distribution). Last parameters appreciably influence to allocation of losses in active parts and a common thermal state of an induction motor. These parameters depend on structure of the main circuit of the convertor, an aspect of regulating and the law of the control used in it.

In a heat calculation the problem of definition of excess of temperatures of various parts of electrical machine over cooling environment temperature is put. Calculation should be made with use of the geometrical dimensions and physical parameters of induction motors and information about losses in various parts of the motor, gained as a result of electromagnetic calculation of the motor. An important feature of controlled induction motor is its operation in a various operating points of a control range. Therefore at thermo analysis the calculations of the steady state thermal conditions occurring at long lasting operation in any operating point are necessary, and also an unsteady thermal conditions at the dynamic transients linked with regulating, starting, a deceleration and reverse of drive.

In practice of research and design of induction motors are applied various computational methods of the steady state and unsteady thermal processes: a method of the equivalent heating losses, an analytical method or a temperature pattern method, a method of the equivalent thermal equivalent circuits (ETC). To the analysis of a thermal state of controlled induction motors can be applied a simplified heat calculation by the method of heating losses and calculation by means of ETC.

Method of ETC is well enough approved in practice of design of series of induction motors. It is grounded on well-designed theory of electrical and thermal circuits and allows to define medial temperatures of parts of a motor. To virtues of this method refer to use possibility at various designs of motors, a possibility of raise of precision of account for the score of magnification of number of devices of an equivalent circuit and refinement of meanings of thermal conductances. Its application for calculation of temperatures of constructive elements of the controlled induction motor should be performed taking into account specificity of operation of the motor in the drive. At calculation following simplifications are accepted: the cage rotor is considered as one device, cooling of end faces of cores of the stator and rotor is not considered, machine cooling symmetrically and uniformly in a cross-section, thermal conductances are independent of temperature. At development of mathematical model of a thermal state of the motor a variety of constructive solutions of controlled induction motor should be considered. It is necessary to provide a possibility of a heat calculation of motors enclosed (IP44, IP54) and protected (IP22, IP23) modifications both with forced, and with self-cooling with use in system of ventilation of axial and radial ventilating ducts. It is developed ETC for heat calculations of nonstationary behaviours of controlled induction motors of the enclosed modification (IP44, IP54) which is presented on figure 7 in which some conductances at regulating vary and in the thermal circuit design they are marked out as variables. ETC for heat calculations in a steady conditions will be converted at exclusion of the devices which are

representing heat capacities. The mathematical description in appropriate way changes. Calculation of variable conductances is necessary for executing for each operating point. The thermal conductances which have been marked out as variables by a dot line, vary at self-cooling and remain invariable at a dusting the independent ventilating fan. In a heat calculation the problem of definition of excess of temperatures (excessive heating) of various constructive parts of the electrical car over ambient temperature is solved. Constructive parts of the electrical machine possess certain heat capacities which values depend on used materials and their geometrical sizes.

At the solution of a problem of definition of excess of temperatures of various constructive parts of the electrical machine over environment temperature in an observed equivalent circuit of substitution following constructive parts of an induction motor are introduced:

1. The stator core (fingers and a back) with medial superheat temperature θ_1 , heat capacity C_1 and power losses ΔP_1 (magnetic losses in the core taking into account the additional iron loss of the stator).
2. The short-circuited cage of a rotor and fingers of a rotor with medial superheat temperature θ_2 , heat capacity C_2 and power losses ΔP_2 (the total of losses of rotor bars, short-circuited rings and the additional losses in fingers and a rotor winding).
3. The grooving part of a winding of the stator with medial superheat temperature θ_3 , heat capacity C_3 and power losses ΔP_3 .
4. Front parts of a winding of the stator with medial reheat temperature θ_4 , heat capacity C_4 and power losses $\Delta P_4 = \Delta P_{el} - \Delta P_3$.
5. Interior air (IA) with medial temperature θ_5 , heat capacity C_5 and interior ventilating losses ΔP_5 .
6. The frame with medial superheat temperature θ_6 , heat capacity C_6 .
7. End shells with medial temperature θ_7 , heat capacity C_7 .
8. In ETC following thermal conductances are presented:

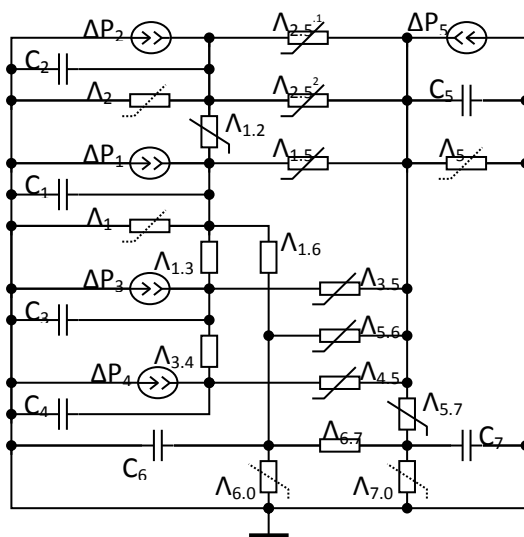

Figure 7. The equivalent thermal equivalent circuit of controlled induction motor of the enclosed modification (IP44, IP54) for the analysis of unsteady thermal processes

Λ_1 – conductance between a package of the stator and a cooling environment at unpackaged modification.

$\Lambda_{1.2}$ – conductance of a stator-to-rotor gap between the core of the stator and a rotor.

$\Lambda_{1,3}$ – shunt conductance of a grooving part of a winding from winding copper to the stator core.

$\Lambda_{1,5} = \Lambda_{rvds} + \Lambda_{avds} + \Lambda_{surf}$ – conductance from a stator package to IA, consists of conductances: Λ_{rvds} the radial, Λ_{avds} axial ventilating ducts of the stator, Λ_{surf} surfaces of the core of the stator to IA.

$\Lambda_{1,6}$ – conductance from a stator package to the frame (for the enclosed induction motors).

Λ_{2-} – conductance from a rotor to chilling air (a scavenged rotor).

$\Lambda_{2,5}^{.1}$ – conductance from front parts of the squirrel cage to IA

$\Lambda_{2,5}^{.2} = \Lambda_{rvdr} + \Lambda_{avdr} + \Lambda_{shaft}$ – conductance from the rotor core to interior air, consists of conductances Λ_{rvdr} the radial, Λ_{avdr} axial ventilating ducts of a rotor to IA, Λ_{shaft} conductance of a rotor to IA through the shaft.

$\Lambda_{3,4}$ – axial thermal conductance of a winding of the stator.

$\Lambda_{3,5}$ – conductance from a grooving part of a winding of the stator to IA through the radial channels.

$\Lambda_{4,5}$ – conductance from front parts of a winding of the stator to IA

Λ_5 – the equivalent conductance considering heating of a cooling medium (for the protected motors).

$\Lambda_{5,6}$ – conductance from IA to the blown frame.

$\Lambda_{5,7}$ – conductance from IA to the bearing shields.

$\Lambda_{6,7}$ – conductance between the frame and bearing shields.

$\Lambda_{6,0}$ – conductance from a frame surface to chilling air.

$\Lambda_{7,0}$ – conductance from bearing shields to chilling air.

On the basis of offered universal ETC the system of differential equations of a heat account can be made. In a matrix aspect the system is represented expression:

$$\frac{d}{dt}\theta = [C]^{-1} \cdot [\Delta P + A \cdot \theta],$$

Where θ – a matrix-column of medial excessive heating over temperature of a cooling medium,

$$\theta = \begin{bmatrix} \theta_1 \\ \theta_2 \\ \vdots \\ \theta_n \end{bmatrix}; \quad (17)$$

C – a matrix of heat capacities of matching constructive devices into which the induction motor is conventionally dissected

$$C = \begin{bmatrix} C_1 & 0 & \dots & 0 \\ 0 & C_2 & \dots & 0 \\ \vdots & \vdots & \ddots & \vdots \\ 0 & 0 & \dots & C_n \end{bmatrix}; \quad (18)$$

Λ – a matrix of thermal conductance

$$\Lambda = \begin{bmatrix} -A_{1,1} & A_{1,2} & \dots & A_{1,n} \\ A_{2,1} & -A_{2,2} & \dots & A_{2,n} \\ \vdots & \vdots & \ddots & \vdots \\ A_{n,1} & A_{n,2} & \dots & -A_{n,n} \end{bmatrix}, \quad (19)$$

Where $A_{1,1}, A_{1,2}, \dots, A_{n,n}$ – thermal conductances between motor devices;
 ΔP – a matrix-column of Joule heat losses in matching constructive devices of the electrical machine

$$\Delta P = \begin{bmatrix} \Delta P_1 \\ \Delta P_2 \\ \vdots \\ \Delta P_n \end{bmatrix}. \tag{20}$$

The solution of this first order system, for example by a Runge- Kutt method, allows to observe a modification of temperatures of constructive devices of an induction motor at transients. Adequacy in MM essentially rises at the account of modifications on each integration step of losses.

Figure 8 shows the calculated temperatures of excessive heating of windings of motors stators θ_c of observed CED for continuous operation within the control range.

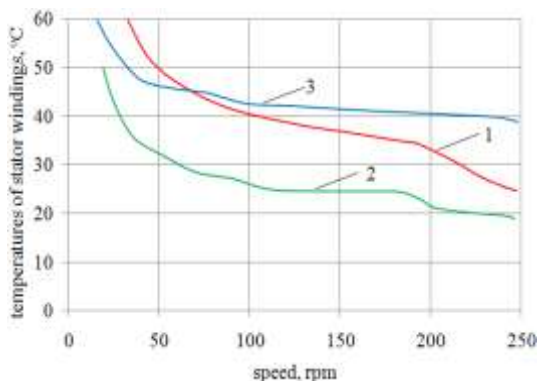

Figure 8. A modification of temperatures of stator windings of motors over the control range: 1 CED without the reducer, 2 CED with the reducer, 3 CED with the reducer and the transformer

The average for the control range design criteria [19] should reflect energy characteristics of CAM in all control range from n_1 to n_2 and are defined as equivalent averaged for this range. The same applies to the generalized criterion of reduced expenditures of the motor which considers cost of manufacture and an expenditure for maintenance. Because expenditures depend on efficiency and a power factor, the generalised criterion of reduced expenditures has various meanings in different points of a control range and it is advisable to determine the equivalent average value of this criterion for the entire control range.

If the control range energy indicators are calculated as the average for the entire range

$$\eta_{aAD} = \frac{1}{n_2 - n_1} \int_{n_1}^{n_2} \eta_{AD}(n) \, dn, \quad \cos \varphi_{1aAD} = \frac{1}{n_2 - n_1} \int_{n_1}^{n_2} \cos \varphi_{1AD}(n) \cdot dn, \tag{21}$$

then a range criteria of given annual cost of the motor can be determined based on the following. When you know the full cost of the engine ced criterion value is defined as

$$RC_{AD} = (ced + C_{rpc})[1 + T_s(k_{de} + k_s)] + CL_{AD}, \tag{22}$$

where C_{rpc} -cost of expenditures for a reactive power compensation, UAH; CL_{AD} -cost of losses of the electric energy for a year, UAH; T_s - standard pay-back period of the motor,

years; k_{de} - a share of expenditures for depreciation expenses; k_s - a share of expenditures for service at motor maintenance.

For controlled induction motors numerical value $T_s = 5$ years, $k_{de} = 0.065$, $k_s = 0.069$ are accepted the same, as for common industrial induction motors. Then

$$RC_{AD} = 1.67(ced + C_{rpc}) + CL_{AD}, \quad C_{rpc} = C_{cre}P_1(tg\varphi_1 - 0.484), \quad (23)$$

$$CL_{AD} = C_{cae}P_{1AD}(1.04 - \eta_{AD}), \quad (24)$$

where C_{cae} - the coefficient considering cost of losses of active energy, representing product of cost 1 $\kappa W \cdot h$ the electric power during life expectancy of the motor ($C = 0.13$ c.u. for $\kappa W \cdot h$), the number of engine operating hours during the year ($T_{year} = 2100$), number of years of operation before big repair (5) and coefficient of relative motor load ($K_L = 0.8$), C_{cre} - the coefficient considering cost of compensation of a reactive energy and representing product of cost 1 kilovar of a reactive power of compensating devices (10 c.u. for 1 kilovar), coefficient of participation of the motor in a peak load of the system (0.25).

$$RC_{aAD} = \frac{1}{n_2 - n_1} \int_{n_1}^{n_2} RC_{AD}(n) \cdot dn. \quad (25)$$

It is necessary to note that at operation the CAM as a part of up-to-date variable-frequency electric drives because of proximity of a power factor of the drive to 1 a component matching to cost of compensation of a reactive energy may be excluded from expression of measure RC of the electric drive

$$RC_{CED} = cep [1 + T_s(k_{de} + k_s)] + CL_{CED}, \quad (26)$$

where cep - an overall cost of the electric drive,

$$C_{CED} = C_{cae}P_{1CED}(1.04 - \eta_{CED}).$$

Numerical values of the coefficients, costs, hours and years are used same, as for definition

RC_{AD}

$$RC_{aCED} = \frac{1}{n_2 - n_1} \int_{n_1}^{n_2} RC_{CED}(n) \cdot dn. \quad (27)$$

Table 1 shows the values of parameters considered CED to which number refer to medial band efficiency (η) and reduced expenditures (RC), and also mass, dimensional and cost indexes of motors and drives are resulted.

Account of cost of losses of active energy for year can be executed

$$CL_{ae} = C \cdot T_{year} \cdot K_L \cdot P_{mech} \cdot (1 + 0.04 - \eta_{CED}) / \eta_{CED}, \quad (28)$$

Where 0.04 - the relative magnitude of losses in a user supply net.

Comparison of the observed alternatives the CED at cost of losses of active energy for a year (Table 2) is executed.

Comparison of the observed alternatives the CED at cost of losses of active energy for a year (Table 2) is executed.

Modelling for each circuit solution of the CED is also executed at operation on set tachogram (starting 1.5 s to 150 rev/min, 1 s – 185 rev/min) taking into account transients.

On Figure 9, Figure 10, Figure 11 and Figure 12 the versus time graphs gained at modelling of operation observed CED on set tachogram are presented.

Excessive heating characteristics display that at each step of tachogram two sections are observed. First matches to the transitive electromechanical process, second - to heat on an exhibitor with a trend of reaching of final values of superheat temperature.

Excessive heating characteristics display that at each step of tachogram two sections are observed. First matches to the transitive electromechanical process, second - to heat on an exhibitor with a trend of reaching of final values of superheat temperature.

Table 1. Comparison of various CED indexes

| Indexes and parameters | CED | CED | CED |
|-----------------------------|---|------------------|--------------------------------------|
| | Without the reducer and the transformer | With the reducer | With the reducer and the transformer |
| η Motor, % | 88 | 93.55 | 90.34 |
| $\cos\varphi$ Motor, r.u. | 0.76 | 0.89 | 0.64 |
| η CED, % | 86.31 | 89.9 | 85.23 |
| RC Motor, c.u. | 102926 | 10908 | 44690 |
| RC CED, c.u. | 205991 | 108381 | 118600 |
| Mass Motor, kg | 1670 | 560 | 325 |
| | Volume | | |
| Motor, dm ³ | 161.7 | 75.6 | 34 |
| Value Motor, c.u. | 18039 | 5437 | 3294 |
| Mass CED, kg | 1745 | 770 | 1040 |
| Volume CED, dm ³ | 290.7 | 255.6 | 666 |
| Value CED, c.u. | 75039 | 63437 | 38762 |

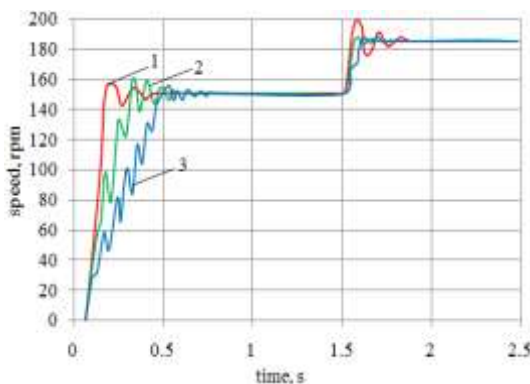

Figure 9. Characteristics of a rotational speed of the mechanism: 1 CED without the reducer, 2 CED with the reducer, 3 CED with the reducer and the transformer.

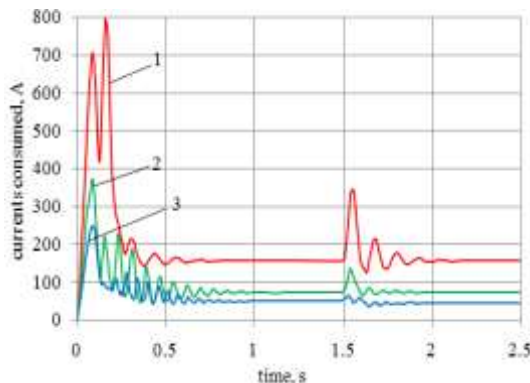

Figure 10. Characteristics of currents consumed by motors: 1 CED without the reducer, 2 CED with the reducer, 3 CED with the reducer and the transformer

Table 2. Comparison of costs of losses of active energy for various CED

| Indexes and parameters | CED Without the reducer and the transformer | CED With the reducer | CED With the reducer and the transformer |
|------------------------|---|-------------------------|--|
| η CED, % | 86.31 | 89.9 | 85.23 |
| Value CED, c.u. | 1299 | 993.36 | 1398 |

Forces of a magnetic, mechanical and aerodynamic origin cause vibration and noise of electrical machines. Magnetic sources of vibration and noise are bound to the higher space and time harmonics of a magnetic field which are caused by presence of fingers on the stator and on a rotor, polyharmonic composition of a supply voltage, a stator-to-rotor gap eccentricity, nonsinusoidal allocation of MMF of a winding, saturation of the magnetic circuit of the machine and a row of other causes. Mechanical causes are lack of balance a rotor, misalignment and a distortion of mounting faces of the bearing, an aberration in the form of their rings and spread of sizes of a separator, a thermal strain of a rotor, a shaft bending flexure etc. The aerodynamic noise is formed by the ventilating fan and other details had on a rotor. Vibrations and induction motor noise were observed by many authors [23, 24, 25].

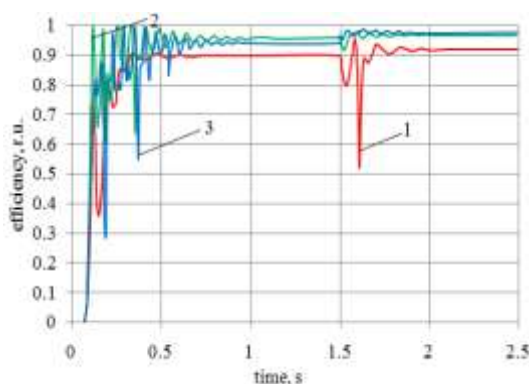

Figure 11. Characteristics of efficiency of motors: 1 CED without the reducer, 2 CED with the reducer, 3 CED with the reducer and the transformer

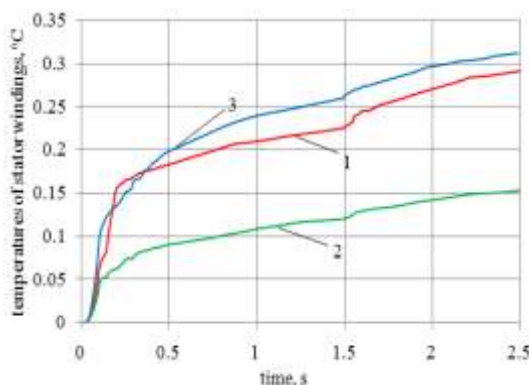

Figure 12. Characteristics of excessive heating of windings of stators of motors: 1 CED without the reducer, 2 CED with the reducer, 3 CED with the reducer and the transformer

The basic singularities of vibration and acoustic processes at induction motor operation in systems of CED are that in a different operating points of an observed control range intensity of all three aforementioned sources largely change, and also resonance appearances are observed. In this connection it is necessary the reviewing of noise levels and vibrations in all

control range for the purpose of their comparison to allowances. Thus it is necessary to consider that a source strength of a magnetic origin is in many respects defined by a harmonic composition of voltage feeding motor, i.e. depends on type of the convertor, an aspect of the regulating used in it, a regime of its operation, the applied law of the frequency control and a drive loading. System approach according to which all functional indexes, including on vibration and noise levels, are defined by joint consideration of operation of all builders going into the drive, allows generating of complex MM of vibration and acoustic processes of CED, invariant to various convertors and loadings. Account vibration and acoustic indexes of a magnetic origin taking into account the temporary harmonic voltage can be executed on a procedure, designed by Shumilov U.A. and Gerasimchuk V. G. [24], according to which forces of a magnetic origin are divided depending on direction of action into the radial and tangential; vibrations and noise are defined from these components. The basic assumption is the conjecture of linearity of a mechanical system at which frequency of magnetic vibrations and noise is equal to frequency of a magnetic force causes it, and the amplitude of deformations is computed by division of the force operating with given frequency, into rigidity of a construction (taking into account a reinforcement of deformations at a resonance). The end result of calculations is plurality of amplitudes of vibrations on matching frequencies (a vibration spectrum) and a common level of magnetic noise. At the same time at use of this procedure in complex MM for calculation of vibration and acoustic indexes of controlled induction motors it is necessary to consider that in each operating point of a control range parameters of equivalent circuits of controlled induction motors and EMF sections of the magnetic circuit of each observed harmonics vary. At such account adequacy offered in MM [12] raises. As a result vibration and acoustic account are defined following vibrations and noise parameters: the relative level of vibrations speed S_v and the level of magnetic noise S_n depending from vibrations speed and the relative radiated power N_{rel} . Their numerical values in a various operating point of a control range of induction motor depend on an aspect of a loading, type of the convertor, an aspect of regulating, the law of the frequency control. At account geometrical sizes and properties of materials of an induction motor, and also magnitude of diameters of the core of the stator, the framework, width of a wall of the stator and the framework, modulus of materials of the stator and the framework and etc. are used. The given procedure can be used for definition vibration and acoustic indexes in dynamic regimes. For this purpose it is necessary to use on each step of the solution of simultaneous equations variable meanings of electromagnetic and electromechanical magnitudes in vibration and acoustic calculation.

On Figure 13 rated dependences of vibrations speed $S_v=f(t)$, vibration acceleration $S_a=f(t)$ and magnetic noise $S_n=f(t)$, gained for different motors in the observed CED are presented. The calculation procedure of ventilating noise of serial induction motors is well completed and confirmed by experimental data [23]. In induction motors centrifugal fans with various constructions of vanes are applied. Structural features of vanes is considered by introduction in initial data of geometrical sizes of used ventilating fans. The relative supply of the ventilating fan represents a ratio of actual supply of the ventilating fan to the maximum supply and is defined by aerodynamic efficiency which in turn depends on a construction of vanes of the centrifugal fan. Level of ventilating noise is defined for various constructions under different formulas with use of the coefficients which meanings are accepted under tables. In the induction motors of CED the ventilating fan rotational speed varies over the control range that stipulates an aerodynamic noise modification. The common level of ventilating noise depends also on type of the ventilating fan and its constructive sizes. Level of this noise in the given control ranges on a known procedure can be defined by means of a program complex for observed alternatives of electric drives [12]. In dynamic regimes (Figure 14) ventilating noise builds up proportionally to a rotational speed, attaining the meanings matching to a steady run.

The known calculation procedure of mechanical vibrations for usual induction short-circuited motors [23] is intended for rigid rotors to which rotors of a induction motors of uniform series refer to.

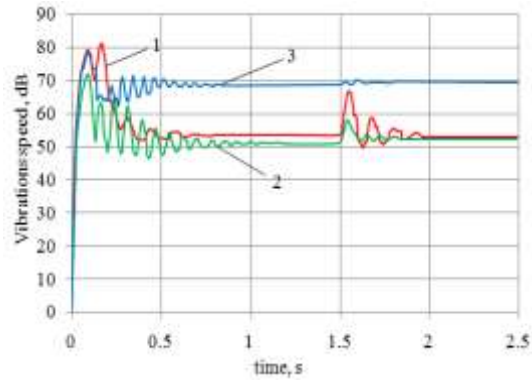

(a)

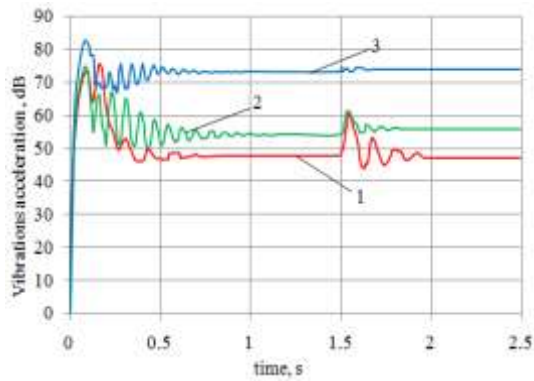

(b)

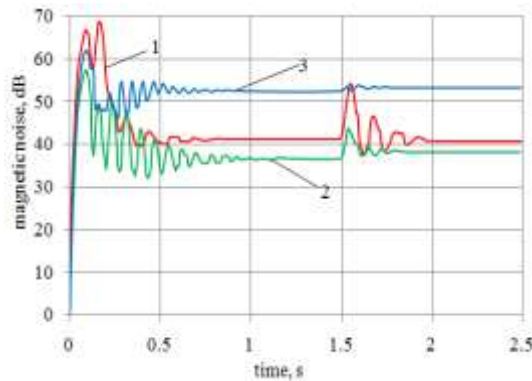

(c)

Figure 13. Vibrations speed (a),vibration acceleration (b) and magnetic noise (c) of motors: 1 CED without the reducer,2 CED with the reducer, 3 CED with the reducer and the transformer

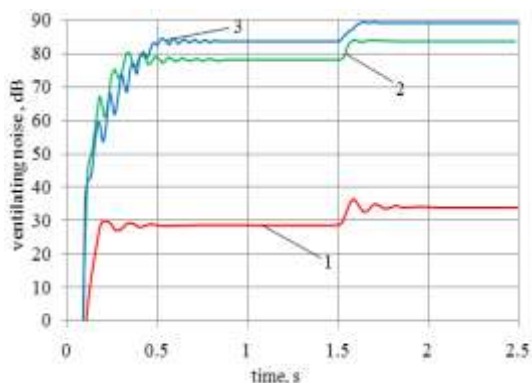
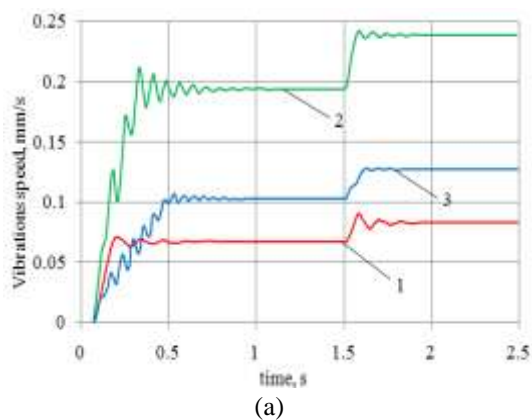
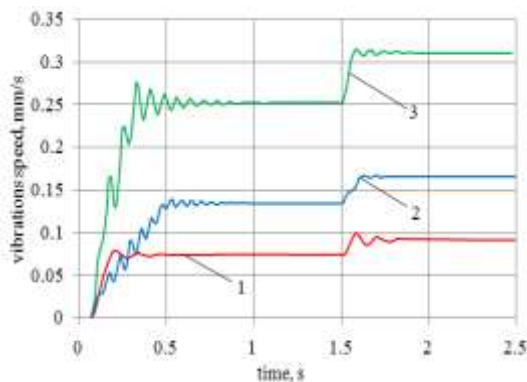

Figure 14. Changes of ventilating noise of an induction motor: 1 CED without the reducer, 2 CED with the reducer, 3 CED with the reducer and the transformer



(a)



(b)

Figure 15. Vibrations speed in the radial direction V_r (a) vibrations speed in axial direction V_z (b) of an induction motor: 1 CED without the reducer, 2 CED with the reducer, 3 CED with the reducer and the transformer

The causes of mechanical vibrations are the residual unbalance at static both dynamic balancing of a rotor and presence of rolling-contact bearings. At calculation of vibrations from rolling-contact bearings it is supposed that on low frequencies the parent of vibrations are an irregularity of manufacture of the bearing on the principal sizes and inaccuracy of mounting, and on frequencies above a 3-fold rotational speed - an irregularity of microgeometry of

bearings, and levels of vibrations are maximum on frequencies of an eigentone of a rotor. Bearing vibrations have the essential technological spread defined by quality of bearings, and also a construction and manufacturing methods of motors. Indexes of mechanical vibrations of controlled induction motors will vary over the control range. They depend on rotor and machine masses, and also from a rotational speed. The end result of calculation of mechanical vibrations are: a common level of vibrations speed from imbalance and irregularities of bearings in the radial direction V_r , a common level vibrations speed from imbalance and irregularities of bearings in axial direction V_z . The maximum magnitude of indexes of mechanical vibrations in the given control range in concrete design alternatives can be defined on a known procedure by means of a designed program complex [12] for comparison of these alternatives. Magnitude of indexes of mechanical vibrations are defined by gyrating masses of the propeller and a rotational speed of a curl and irregularities of manufacture of bearings and inaccuracy of mounting depend on an unbalance.

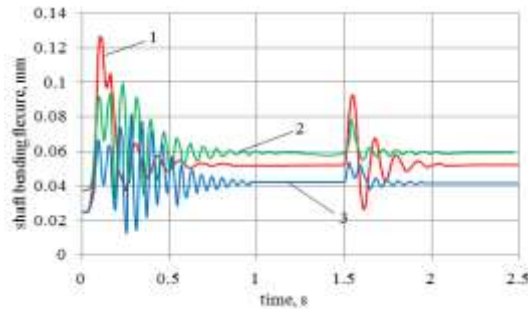

(a)

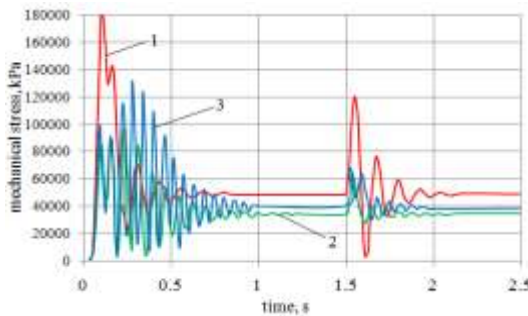

(b)

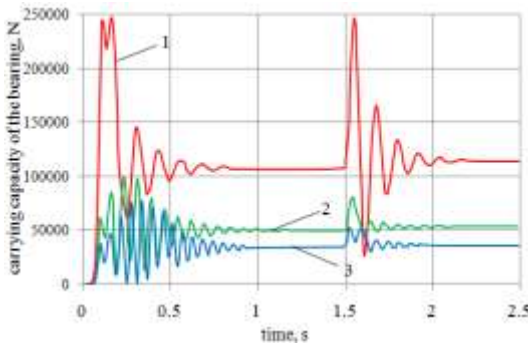

(c)

Figure 16. A modification of mechanical indexes of motors. resultant shaft bending flexure (a) reduced mechanical stress(b) dynamic carrying capacity of the bearing (c): 1 CED without the reducer, 2 CED with the reducer, 3 CED with the reducer and the transformer

In dynamic regimes (Figure 15) mechanical vibrations build up proportionally to a rotational speed, attaining the meanings matching to a steady run. Calculations of indexes of mechanical vibration are executed at the condition of inaccuracy of machining, equalization and an irregularity of manufacture of bearings an equal 1 micron.

At mechanical calculations of an induction motor in operation steady runs three factors characterising a mechanical state, - rigidity of the shaft, strength of the shaft and dynamic weight-lifting capacity of bearings [17, 22] are observed.

For an estimate of a mechanical state of an induction motor at regulating it is offered to observe the same factors in dynamic modes of operation according to set tachogram.

At shaft calculation on rigidity the mechanical index - resulting bending flexure of a shaft f is defining. Except the basic bending flexure of the shaft depending on masses of an active steel of a rotor and a short-circuited winding, the additional bending flexure of the shaft which meaning is proportional to a motor torque is observed. The shaft bending flexure is called also by forces of a single-sided magnetic attraction which originate at rotor bias. It is possible to count magnitudes of a bending flexure of the shaft while motor speed regulating, using in known algorithm [17, 22] magnitudes of the motor torques, varying throughout a transient process according to set tachogram. These magnitudes can be gained by consideration of unsteady electromechanical processes as a result of the solution of the above-stated system of differential equations. At shaft calculation on strength reduced mechanical stress σ , considering combined effect of stress of curving and twisting is defined. Using magnitudes of torques of a motor varying throughout regulating, it is defined reduced mechanical stress at regulating.

Definition of modifications of rated dynamic weight-lifting capacity of bearings C_b at regulating is carried out analogously taking into account type of the bearing and character of a motor load. Designed mathematical models are used in the program [12] with which help examinations of a mechanical state of the motor at regulating have been executed. At the analysis it is accepted joining of motors with actuating mechanisms by means of elastic clutches. In examined electrical machines ball-bearings are used. At examinations character of a loading with moderate jolts is accepted. The overloading coefficient, equal 2,5 for reversible machines is used. On Figure 16, a, b, c the results of calculation of the mechanical indexes set forth above are presented accordingly at regulating of motors in observed CED.

4. Conclusion

1. On the basis of modelling of various CED, inclusive reducer and the matching transformer, which are ensure a demanded control range at a given load, operation of different motors was investigated, therefore comparison of characteristics of motors in static and dynamic regimes is carried out, energy, mass and dimension parameters of electric drives are defined.
2. The carried out investigations give the chance to justify sampling of the best alternative of the drive depending on the chosen criteria, including measure of active energy losses cost.
3. Magnitudes of efficiency of motors for a static conditions are approximately equal to final values of efficiency in transient regimes accordingly tach gram.
4. View overheating characteristics determined by the increase of heating losses in dynamic mode and the heat capacity of the thermal circuit designs of the motors.
5. Dependences of vibration speed and noise of a magnetic origin for examined motors place in one order, unlike dependences of vibration acceleration.
6. Ventilating noise of the motor 4A355M12 is much less than noise of two other motors as it in the core proportionally depends on a rotational speed of the motor shaft.
7. Vibration speed in the radial direction V_r and vibration speed in axial direction V_z the greatest for the motor 4A250M4 and the least for the motor 4A355M12.
8. The peak value of resultant shaft bending flexure in dynamic regimes for the motor 4A355M12 exceeds, and for two other motors does not exceed a legitimate value (0,1 from magnitude of a stator-to-rotor gap).

9. For all motors the peak value of reduced mechanical stress of shafts in transient regimes do not exceed a legitimate value matching to steels of shafts.
10. The peak value of rated dynamic weight-lifting capacity of the bearing in transient regimes for the motor 4A355M12 exceeds, and for two other motors does not exceed a legitimate value matching to type of the bearing.

5. References

- [1]. Shreiner R.T. Mathematical modelling of AC drives with semiconductor frequency converters / *Ekaterinburg: URORAS, 2000. 654 p.*
- [2]. Baclin V.S., Gypels A.S. Mathematical modelling of variable frequency induction motor // *Electromechanical energy converters: Proceedings of Intern. Scientific and engineering. Conf. -20-22 October 2005.- Tomsk: TPU, 2005- pp.143-146.*
- [3]. Chermalykh V.M., Chermalykh A.V., Maidanskiy I.Ya. Investigation of the dynamics and power indicators of asynchronous electric drive with vector control by the method of virtual simulation // *Problem of automated electric drives. Journal of the National Technical University "KhPI", Kharkov 2008, 16:pp. 41–45.*
- [4]. Moshchinskiy Yu.A., Aung Vin Tut, "The generalized mathematical model of a frequency-controlled induction motor with taking into account steel core losses", *Electricity, Moscow 2007;11: pp. 60–66.*
- [5]. A. Khezzar, M. El Kamel Oumaamar, M. Hadjami, M. Boucherma, H. Razik, "Induction Motor Diagnosis Using Line Neutral Voltage Signatures, " *IEE Transactions on Industrial Electronic, vol.56, no.11, pp.4581,4591, Nov. 2009.*
- [6]. Shestacov A.V. A mathematical model of the performance of asynchronous motors with frequency control, " *Electrical engineering"–2011;2:pp. 23 – 29.*
- [7]. Chermalykh V.M., Chermalykh A.V., Maidanskiy I.Ya, "Identification and optimization of electromechanical system parameters by computer simulation", *Bulletin of National Technical University «Kharkiv Polytechnic Institute». – Kharkiv: HTV «XIII», 2010, №28. – pp. 45-48.*
- [8]. Chermalykh V.M., Chermalykh A.V., Maidanskiy I.Ya. Identification of the parameters of the physical system frequency-controlled induction drive and its simulation model // *Electrotechnical and computer systems. - 2011. - № 3.- pp. 35-37.*
- [9]. S. Nandi, H.A. Toliyat, X. Li, "Condition monitoring and fault diagnosis of electrical motors-a review," *IEEE Trans. Energy Conversion, vol.20, no.4, pp.719-729, Dec.2005*
- [10]. Petrushin V.S., Yakimets A.M. Simulation of dynamic modes of induction motors with frequency control // *Problem of automated electric drives. Journal of the National Technical University "KhPI", Kharkov 2001,10:pp. 156–157.*
- [11]. Petrushin V.S. Tutorial "Induction motors in the controlled-speed electric drives"//, " *Nauka i Technica" Publishing, Odessa, 2006, – 320 p.*
- [12]. Petrushin V.S., Riabinin S.V., Yakimets A.M. "The software product "DIMASDrive". The program for analysis, selection and design of asynchronous squirrel cage motors in the variable speed electric drive systems (registration certificate program PA №4065)". *Kyiv: State Department of Intellectual Property of liability, 26.03.2001.*
- [13]. Frequency converters. Series FR-A 540.– <http://univolts.ru/trademap/electric/mitsubishi/invertors/fra540>
- [14]. Plant of drive technology. Characteristics of gear". *Main technical data of gearboxes.- http://www.reduktor-ptp.ru/.*
- [15]. Production of transformers. "Characteristics of the trans-shaper". *Main technical data of transformers.– http://transtechno2.ru/produksiya-3/*
- [16]. Borisenco A.I., Kostikov O.N., Yakovlev A.I. Cooling of industrial electrical machines. – " *Energia" Publishing, Moscow, 1983. – 296 p.*
- [17]. Gjldberg O.D., Gurin Y.S., Sviridenco I.S. Design of electrical machines.– " *Higherschool" Publishing, Moscow, 2001. – 430 p.*

- [18]. Bepalov V.Y., Dunaikina E.A., “Moshinskiy U.A. Unsteady heat calculations in electrical machines”, Edited by B.K. Clokov. Mosk. Energy. *Institute Publishing, Moscow, 1987.* – 72 p.
- [19]. Petrushin V.S. “Design synthesis of high efficiency induction motor upto 400 kW”, *Dis. Dr. tehn. Sciences: 05.09.01. – Odessa, 2001.* – 379 p.
- [20]. Petrushin V.S., Yakimets A.M. Universal thermal equivalent circuit of induction motors // *Electrical machine ryand electrical equipment, Odessa, 2002;59: pp. 75–79*
- [21]. Petrushin V.S., Yakimets A.M., Cobrin V.L. Thermal calculations of unsteady modes of induction motors of controlled drives, *Electrical engineering and Electromechanics, 2003.* – №4. – p. 65 – 68.
- [22]. Kopylov I.P., Clokov B.K., Morozkin V.P., Tokarev B.F. Design of electrical machines. Textbook for High Schools. “*Higherschool*” Publishing, Moscow, 2005. – 767p.
- [23]. Unified series of asynchronous motors Interelectro; Edited by V.I. Radin. – – “Energia” Publishing, Moscow, 1990. – 374 p.
- [24]. Shumilov Y.A., Gerasimchuk V.G. “Study of magnetic perturbing forces in induction motor when powered by static frequency converter”, *Tech. electrodynamic, 1997.* – №4. – pp. 44 – 48.
- [25]. Shumilov U.A., Chebanuk V.K. Induction motors with improved vibration and acoustic performance. – *Kiev: Technic, 1991.* – 169 p.



Viktor Petrushin head of Electric Cars Department, ONPU, 65044, Odessa, Shevchenko av., 1, ONPU, ph. (048)734-8494.



Vladimir Vodichev head of Electromechanical systems with computer control Department, ONPU, 65044, Odessa, Shevchenko av., 1, ONPU,



Rostislav Yenoktaiev Master of ONPU, 65044, Odessa, Shevchenko av., 1, ONPU, ph. (097)046-30-70.